

THE METHODS OF JEAN PAIN OR " ANOTHER KIND OF GARDEN "

CONTENTS :

2. - The end of big forest fires
3. - A new source of HUMUS
4. - Cultivation without watering
5. - The FUNDAMENTAL food of the soil
6. - Industrialization of brushwood composting
7. - Production of ENERGY (hot air, hot water) and uses : heating, domestic uses, etc.
8. - A small CHIPPER... with big capabilities
9. - BRUSHWOOD GAZ, the ENERGY of TOMORROW
10. - The JEAN PAIN plan for thicket clearance and rational use of the residual forest biomass.

*Reafforestation will be
the mark and work of
the authentic civilization*

Jean PAIN.
(1928-1981)

IDA AND JEAN PAIN 

Knight of the Order of Agriculture

THE METHODS OF JEAN PAIN

or

" ANOTHER KIND OF GARDEN "

Translated from the French
« LES MÉTHODES JEAN PAIN »

ou

« UN AUTRE JARDIN »
by Ann Pellaton, B.A. (Hons.)

NOW IS OUR LAST CHANCE

ENVIRONNEMENT

AGRICULTURE

ENERGY

*This work is also published in French (original version),
Dutch, Spanish and German.*

This book contains eighty-eight pages numbered from 1 to 88,
excluding cover.

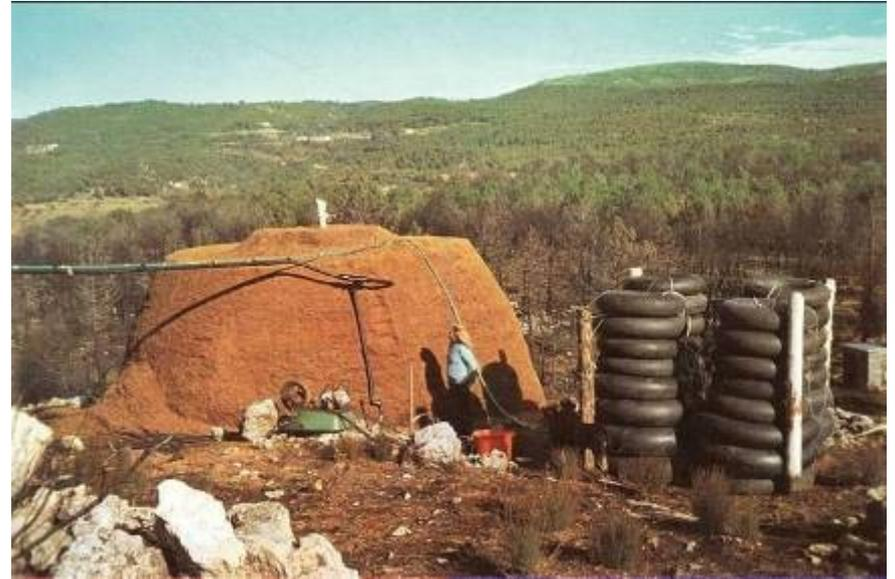

Gas and hot water production system



House equipped according to our Methods

LETTER - PREFACE

by **HENRI STEHLE**

Laureate of the Institute, Doctor-Engineer, formerly Director of Research at the National Institute of Agronomical Research (NIAR)

to M. and Mme. Jean PAIN, Templiers Estate

Domaine des Templiers

Dear Friends,

The problems in the minds of Man called SAPIENS or TECHNOLOGICUS in this atomic age, even on the clear, sun-soaked shores of our Mediterranean, the source of civilisation, are complex, numerous, varied and acute. Many are a long way from finding a satisfactory answer to them.

Here, through your manuscript, Madame Ida Pain, we can both read, like a watermark, the wording of the questions, and at the same time find there, either dotted or lightly sketched in, the answer which Jean has tried to provide, a personal, original answer, and one which expresses but one desire, to serve and be ready to help.

Do we not hear these questions daily on our Mediterranean coast, and especially here in Provence, a region which has the reputation of being well-balanced and harmonious, and yet where today the effects of a new-style materialism are being felt very acutely ?

Are we to let the garrigue and forests of Provence be destroyed by fire and the Mistral's blast, when the moral, material and above all physical benefits they afford in this over-industrialized world are of vital importance to Man, that destroyer of space and at the same time seeker of open spaces of which he himself is the greatest destroyer?

Will the race for humus, this « organic gold rush » as it were, eventually come to a halt before we reach the tragic irremediable point of exhaustion which looms there on the horizon, now that mineral fertilizers, synthetic manures, pesticides and weed-killers have completely taken over, killing off the tares, certainly, but all too often the wheat and Man as well ?

In our present social phase, where the search for pleasure has become a national institution and in which recourse to drugs or a new community way of life are both ways of expressing the boredom and disappointment of young people faced with the mistakes of their elders, you had the idea, as did the idealists around you, of bridging the gap that separates two successive generations, of returning to nature and searching for an Environment which really corresponds to an improvement in the « quality » rather than in the « standard » of living, and you

wondered, judiciously, if the forest, the garden and the family unit did not, in fact, provide the three keys that could open up the doors on to a future of rediscovered equilibrium, peace, labour, fresh air and a return to Nature? .

You set « Burnt Land » against « Green Belt », with its synthetic, renovating, protective and life-giving effect, even when it appears to be disorganized, as when the leaves fall..., but leaves can be shoveled up and turned back into precious humus, creating a new point of departure and regeneration in the heart of a living, constantly fertile soil.

Protecting the forest as you do, you are careful, when cutting down the sometimes dense, prickly and impenetrable thickets in the aromatic maquis, not to forget that this vegetation is also the home of numerous species of avifauna and of a host of organisms, which, from bacteria, micorrhize and the small earth worm right up to the larger animals, whose reputation is as bad as it is false, form the biological cycle and alimentary chains and maintain the equilibrium indispensable for life.

You felt all this even before demonstrating it, just as that British poet, Thomson, inspired and moved by a feeling through which poetry has often been the prophet of science, cried out, «Don't cut a flower or you may set a star off course.» He too had felt that life, even in its most elementary plant form, is linked together by chains, from which vibrations, waves and light are not excluded, going as far as the spaces between the stars, whereas the materialists, as far removed from poets as scientists are, find there only ponderable and... valuable... substances and corpuscles.

Here on this Templier Estate, where, from the land of snows and lakes of your native Helvetia, you came to live nine years ago and which you loved immediately, the breath of the occupants, agriculturists, monks and knights of several centuries ago has passed over you. You have studied their history, felt the passions they felt, tried to discover their mysteries and their spiritual treasure. You have not found money (you are a disinterested man and money does not preoccupy you) but you have found their treasure which is the source of satisfactions, their ethic of a happy environment, achieved by living a simple life, one of observation, reflection, experimentation and usefulness, seeking for good, trying to improve and to contribute to the human race. Their search for the silvan-cultural-pastoral equilibrium in diversified Nature has helped you to safeguard and use the products of Nature judiciously for Man's benefit, taking care never to disturb the biological balances, but, on the contrary, to protect them.

The picture you have formed in your minds of these illustrious predecessors, whose famous sculptured stone cross and chapel are present there before you day after day, keeping their memory alive, is certainly not the same image as the one that the host of historians or novelists who have described them have in their minds. Polyvalent,

warriors, bankers, (the king's own) builders, hoarders, monks; this is how they appear through the pages of the abundant literature which has been written about them. But you, who refuse to be a writer, you have met them, on this very Estate which it is your job to «guard» and you Ideal to « safeguard », on the land of the artist and protector of Nature, of which Man, you have not forgotten, is one of the elements. It was in the calm, vivifying forest, an ideal place for reflection, in the garden, this « abode of God », whose blessings they praised in low Latin from their very origin, in the pastures, among your goats, all the way through the silvan-cultural-pastoral cycle (their sylvia, ager and saltus that you met these peasants of the Temple. Their Cistercian tradition has shown us the way towards modern phytosociology and agronomy in our present-day scientific world which is researching causes and organisations which were already preoccupying Olivier de Serres in « Mesnage des Champs ».

Your approach has been the opposite to the one which is usually practiced. Engineers, agronomists, scientists, botanists... foresters, teachers and writers progress from study to application, from theory to practical, from professional training to employment. But you have asserted that you are not a man of letters, « of writings », as your wife says, and you also deny that you are a scientist... And yet I know how many works on agronomy, pedology and phytosociology you have read and studied, to the extent that the names of Brétignières, Demolon, Burgevin, Kunholtz-Lordat and other great masters of agronomy and ecology, are all well-known to you, as are the methods of Indore for making artificial humus and those of the researchworkers of India.

But our friend Jean is self-taught, with all that that implies of freedom, introspection and desire for learning, having first of all made observations and asked himself questions. The course of his personal and family life and of his professional and intellectual life has thus been profoundly and favourably modified. Time has taken on another dimension, and through observing Nature, Jean now sees the Environment through different eyes from those which used to see the big towns where he used to live; this Provençal countryside, with its aromatic plants and heady perfumes has penetrated his family life, and he has been motivated by but one idea, that which Noah Gordon recently, in « Doctors » had the father writing to his son, « Always do as little ill as possible, try to create or achieve something which, had it not been for you, could not have existed. » This is just what Jean, with the help of his wife, has tried to do, the best possible good, the creation of something new.

In this text, which has been written by his daily witness and collaborator of every minute, including the « report », one will see how well he has succeeded. He has gone about it in no ordinary way but his classroom has been the garigue, the forest, the garden and the meadow. First of all he has observed, pondered, experimented, read the great book of Nature, following the example, though unconsciously, of the

Templiers and the Cistercians, and then, but only then, has he sought the explanations in science, sometimes in European science, sometimes in that of the New World or of the sages of India.

From the practical application, from the experiments and the results he has recorded, he has then gone back to examine the causes; from the practical he has moved to the theory, up from the land and the forest towards the sky and the light of photosynthesis.

If the path Jean has trodden is not the traditional one, nor the one which all men tread, who is to complain?

« NOW IS OUR LAST CHANCE ». - it is given us, so that our youth shall not be driven to drugs, nor incited to violent behaviour, so that fire and erosion shall not be left to ravage the forests and soils, animals and men of our Provence-Côte d'Azur, and finally so that anarchic urbanization of the sylvia, after the development of a concrete wall on the bank of the Mare Nostrum, shall not be allowed to continue. We welcome this book of pictures, advice, experience and techniques with satisfaction and gratitude, for it is a book written in every day language and with expressions of love for one's neighbour

If is indeed « ANOTHER KIND OF GARDEN », not the kitchen garden, the orchard or the flower garden which we have around us or which has disappeared, but a dream garden, without pollution of any kind, without disease, without parasites and without depredators; a garden which has a big yield, even when it does not receive constant attention such as watering, hoeing, weeding, as is generally necessary in agriculture. No watering in a dry region - that does sound paradoxical. And yet, the undeniable truth is there. The organoleptic character of the vegetables and fruit obtained here prove their superior quality.

Thank you to the author, Ida, and to the one who has realized all this, the hero of this rural epic: Jean Pain.

H. STEHLE.



THE METHODS OF JEAN PAIN

OR

" ANOTHER KIND OF GARDEN "



The Art of using forest brushwood in silviculture and agriculture in conjunction with fire-prevention, and to enrich soils in Humus.



To all who sincerely wish to safeguard woodland and encourage reafforestation.



To all, too, who wish to eat wholesome, perfectly balanced foods



Finally, to the agriculturist who lies dormant in every man, and every man preoccupied with the energy problems of his time.



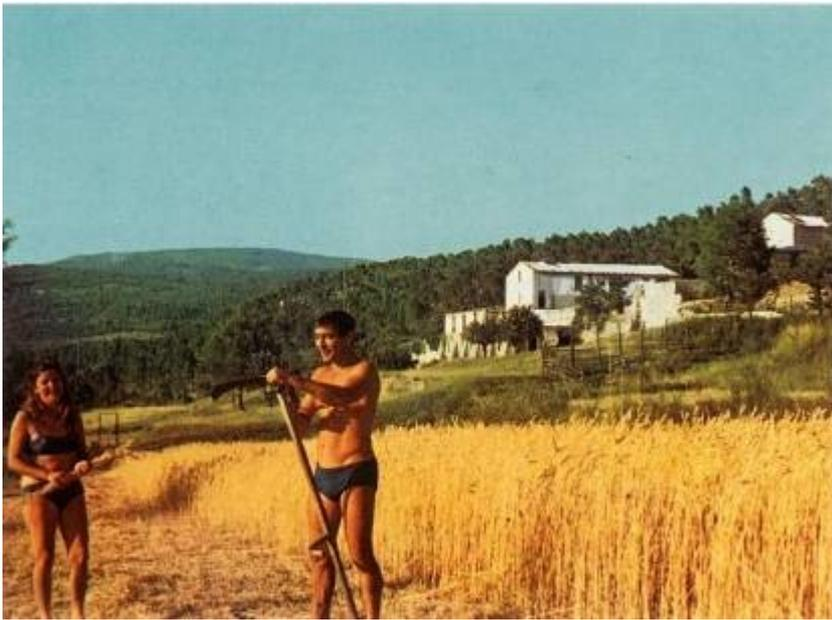

FOREWORDS

It all started for Jean Pain one day, many years ago, when a man arrived at our house and said to him. « Why don't you cultivate the land? Do some gardening, plant some trees, cultivate the vineyards, grow your own wheat and make your own bread! »

The man's name was Marcel Bretineau, and he died not long afterwards, without having been able to tell Jean Pain anything more about the subject, except that the laws of nature must be respected.

Several years passed, studious, laborious years, during which Jean Pain became immersed in texts, avidly reading all about forestal and agricultural science. He conducted multifarious experiments on our land. Jean Pain was researching.

Since then a great many people have asked him repeatedly to explain in writing his method for bringing out the best in the soil, and so I feel that none better than his own life-partner could explain it for him, since Jean Pain himself is not one for writing.

Not having my husband's erudition in agricultural matters, I shall try to express myself clearly and simply, my one hope being that all will understand. I shall therefore avoid the pitfalls of scientific agronomical terms.

ANOTHER KIND OF GARDEN (I find no title more eloquent) will be one in which any soil at all can be cultivated and any plants grown, a garden in which no treatment of any kind, preventive or curative, will be applied, considering as we do that a treated soil or plant is incapable of producing a sturdy lineage.

« If a plant becomes diseased», says Jean Pain, « either through some deficiency or fungus attack, the only person responsible is the agriculturist, and it will be up to him to "find a perfectly-balanced food for the soil, to prevent the same thing from recurring.

Palliating the disease by applying some product could cause the line to be weakened and thus lead to an increasing, persistent unbalance ».

Jean Pain goes on to say, « I don't think there is any global method or uniform process when it comes to working on the land.

It is the agriculturist who should adapt himself, indeed must adapt himself, to the land for which he is responsible, this land which is lent to him and from which he must bring out the best for everyone's benefit, not least his own, taking into account its character, its personality and its behaviour according to the climate, the pedology and the geology.

Only one thing should be general, polyvalent and indispensable. and that is to give or give back HUMUS to the land in any form at all, and to add, NOW IS OUR LAST CHANCE; economically, Man must take action, nobody has the right now to burn any kind of organic matter, whether it be household rubbish, town waste from sawmills and packing factories, or brushwood obtained from thicket clearance. And yet every year, millions, yes, millions of tons of brushwood, by-products of the forest, are available for agriculture; it is very cheap, but incomparably rich ; it provides the only fertilizer which, as well as being the immediate and perfectly-balanced food for the soil on which we grow plants for our sustenance, will at the same time become the nutritive HUMUS of tomorrow. It is ideal for all types of cultivation : cereals, grassland, fruit trees, vines and also for vegetable-growing, horticultural and floral cultivation.

1. - ENVIRONMENT : THE FOREST it from fire, always a
 gi d be done by judicious
 thicket clearance; it is THE RADICAL AND ONLY SOLUTION to the
 problem of forest fires.

By judicious clearance, I mean that very bushy spots with dense foliage and thick copses should be kept, so that birds can nest and wild animals make their homes and find shelter, well away from any highway, obviously. Clearance should be carried out according to a chequer-work plan adapted to the relief of the ground and divided into squares like a draught-board.

Of course, thicket clearance costs money and ENERGY and up to now it has brought nothing in return; it has just been a gulf swallowing up departmental and national funds.

Now, for the first time, thanks to brushwood composting and the organic manure and ENERGY obtained from it, we can envisage the possibility of rescuing the forest of the French Mediterranean Basin from the threat of fire from Menton to Biarritz, without cost to the State, at the same time fertilizing and building up the land which is poor or disastrously weak and totally lacking in HUMUS.

In this way everyone will gain something from it. Incidentally, I have been most surprised that out of all the people who have been to see me over the past few years, people competent in forestry and agronomical matters, I have not had anyone question the idea; far from it, there has been approval all round. There is always room for hope, since anything is possible.

The use of brushwood compost in the reforestation program will enable all plantations of trees to take better and grow more quickly.

In this way, years can be gained when building up a forest which has been destroyed by fire and where the basic HUMUS has also been burnt, laying bare the mother rock. I have in mind the Estérel, the Maures and Corsica among others, also the Coast Ranges of California and the spurs of Sierra Nevada which we visited during a recent stay in the U.S.A.

Equipment for industrial chipping and composting was invented years ago, and has been used for composting town-waste for a long time now; why should the rural milieu which needs it so much not use it for this vital regeneration?

(Authors' note - We have since produced our own equipment for chipping and refining, following a big demand occasioned by the application of our methods in forestry and agriculture).

The equipment, which is perfectly adapted to this purpose, is presented, with its technical characteristics, on [pages 57, 58 and 59](#).

FEEDING THE SOIL

« One should do one's best », says Jean Pain, « to keep as close as possible to the forest's own teaching.»

The soil's food is first and foremost vegetable matter, which he qualifies when it is green as living vegetable matter.

Great care should be taken to use it like this for elaborating composts wherever possible.

By putting a substance like this back into the soil after composting, a piece of land, however poor, will become fertile and suitable for vegetable growing.

From a minute blade of grass to the gigantic Sequoia, every plant is potential HUMUS.

Brushwood compost will be for the soil both food and framework,
"LIVING HUMUS" *.



RAW MATERIAL

From this close-up we can easily recognize the plants which have been gathered for the compost: oak, pine, heather, thyme, rosemary, lavender, savoury, broom, cade, juniper, lentisk, gorse, filarial, several varieties of spurge, Phoenician juniper, fern, euphorbia, daphne, rue, salsaparilla, etc. in fact any plants at all, without exception, selection, preference or proportioning.

The essential factor is variety. It is in this way that the balance will be achieved in the compost.

There is just one restriction, and that is that the diameter of the biggest branches should not exceed 8mm in the case of manual composting.

That implies that the chlorophyll should not be completely eliminated, or that would destroy the plants, but some of the boughs and branches cut down. Incidentally, being tenderer and less woody, they decompose more quickly. It is not a case of doing away with the screen of plants completely, but simply of thinning it.

In this way we can play our part in the protection of the environment.

In the case of composting on a larger scale, justified by the recycling of the product obtained from large cleared areas (road-sides, forest-tracks, fire-prevention «screens », etc), this 8mm diameter will be considerably exceeded.

The technique of « refining » and composting will then be different. We shall be developing that subject on [page 48](#), in the chapter headed « INDUSTRIALIZATION OF BRUSHWOOD COMPOSTING. »

* LIVING HUMUS: the soil's fundamental food; towards the end of this book, we shall see how to use brushwood compost in various ways as a general fertilizer for all soils.



COMPOSTING AREA

Here we can see Jean Pain taking advantage of a rainy day to wet the freshly-gathered brushwood, with a view to preparing a compost heap. It is always advisable to have a very large composting area at one's disposal. This will allow one to work without restriction of movement during the various phases of the job. Here, for example, it is a forest clearing, with little vegetation and a flat surface. Like that it will be very easy to collect rain-water, by spreading tarpaulins on the ground with their edges upturned. This is for cases where no other sources of water are available.

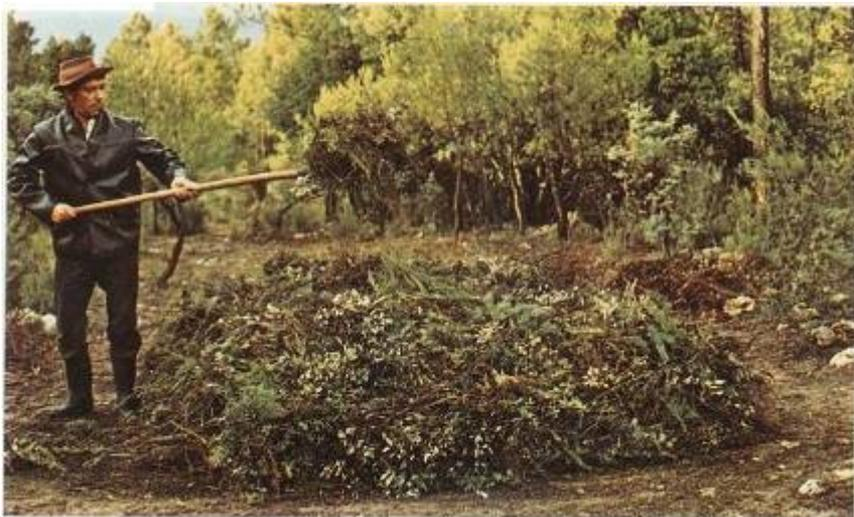

THE DEMONSTRATION SITE

This is the site which Jean Pain chose to demonstrate to a few friends the value of brushwood compost. Practically speaking, the land is not arable. Briefly, the position and characteristics of this soil and the micro-climate are as follows: the site is ten meters from the top of a rocky summit, of which the highest point is 420 meters. Big chalky rocks, sandy subsoil; water is 95 meters below the surface. Capacity for humidity retention, nil. The site faces due south. Geographical situation: the heart of Provence. Dry, scorching summers (average daytime temperature from end of June to end of August, 35°C in the shade). In the foreground you can see an area of scanty vegetation which existed on the site of the garden two years before this photograph was taken.

Here we are at the end of June. That particular summer the small amount of shade was provided by pine branches which had been cut down nearby. This shade is present only in May and June, so as to enable the bedded plants to take root properly, ready to face the torrid summer we always have here. Right at the beginning of July, these boughs are removed and can be used again, as the final covering for a compost heap, for example.

According to Jean Pain, this shade is indispensable in the case of cultivation without watering. That does not apply, of course, when the plants are watered at the time of bedding and for a few days after.

Here, none of the plantations gets a single drop of water; however, as will be shown further on in the case of the leeks, when there has been a long period of dry weather prior to planting, the roots will have to be coated. This is done by dipping the roots into a mixture of compost, water and clay, and so calls for small quantities of water.

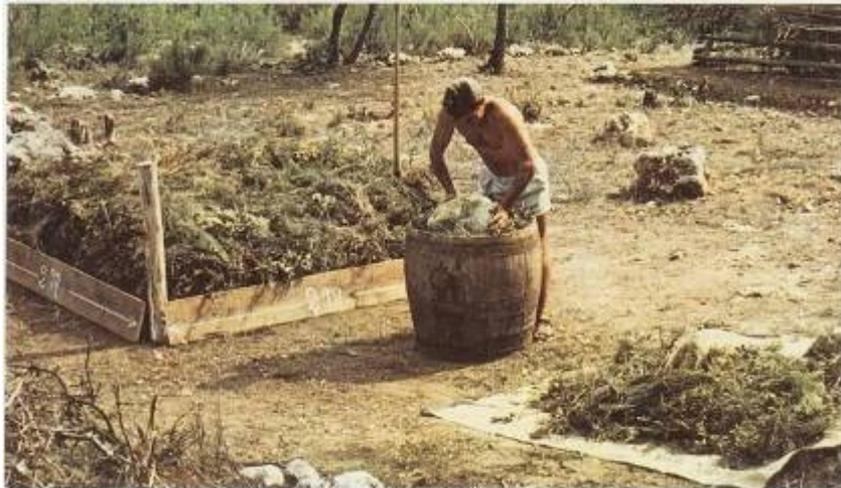

IMPREGNATION

There are several ways of impregnating vegetable matter for composting.

The first way is to turn the vegetable matter over and over in driving rain, and then quickly put it into a heap (see [page 14](#)). This is when no other means are available. The second way is to water the heap, either with a watering-can, or else by short, repeated sprayings, so that the heap can retain this water. The third and last way, and the one Jean Pain finds the most rational, is to plunge the vegetable matter into a barrel, tub, pan, or any other non-metallic recipient. We can see him doing this in the picture above.

As the brushwood is brought into the composting area, it should be piled into the empty barrel and trodden down firmly. It should then be kept pressed down with a heavy stone, and then the barrel filled with water.

Then leave it for a day or several days, depending on the diameter of the biggest branches. After that, fork it out of its «bath », drain it well, and put it on the heap. This process is repeated as many times as necessary, to obtain a minimum volume of 4m of compact, moist brushwood, adding the water absorbed. (Further information on [page 24](#)).

This is in fact the minimum volume which will allow adequate fermentation. There is no maximum volume, obviously. That depending on the gardener's own possibilities. However, Jean Pain finds it better to make several successive heaps, rather than just one large heap, for availability reasons.

It takes a good three days' work for one man to gather up and impregnate this volume of brushwood, which will produce two tons of compost ready for use.

This is the starting point for successive stages, which will result, 111 days later, in a brushwood of the finest quality, provided that all the following operations are carried out carefully, scrupulously and accurately.

16 For the operation to succeed, all the factors must be taken into account



Three weeks have passed since the last day of impregnation. The heap has sunk and softened. We decide to compost.

With the fork face-down (prongs downwards), proceed to a kind of carding, by tapping the edge vigorously again and again; in this way the vegetable matter will unravel and shred. Then put it to one side or behind. It takes just an hour and a half's uninterrupted labour to card the whole of the heap; the vegetable matter can now be seen to look different; it has turned a brownish colour and smells sour. It is slightly warm, meaning that fermentation has begun.



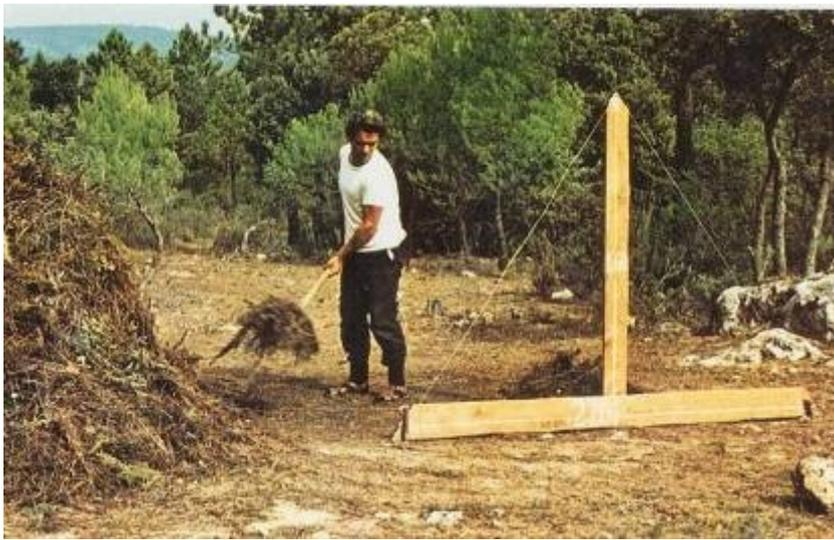

Of all the stages of composting, this is the one in which accuracy is the most essential. The measurements should be scrupulously respected. Width at base 2 m 20. Height at centre 1 m 60, triangular in shape. Length determined by the amount of brushwood to be composted. Fork this on to the heap, layer by layer, and this time do not press it down.

If you are careful to toss it into the central axis every time as shown above, you will find that the heap falls into shape as you go along.

This takes half an hour.

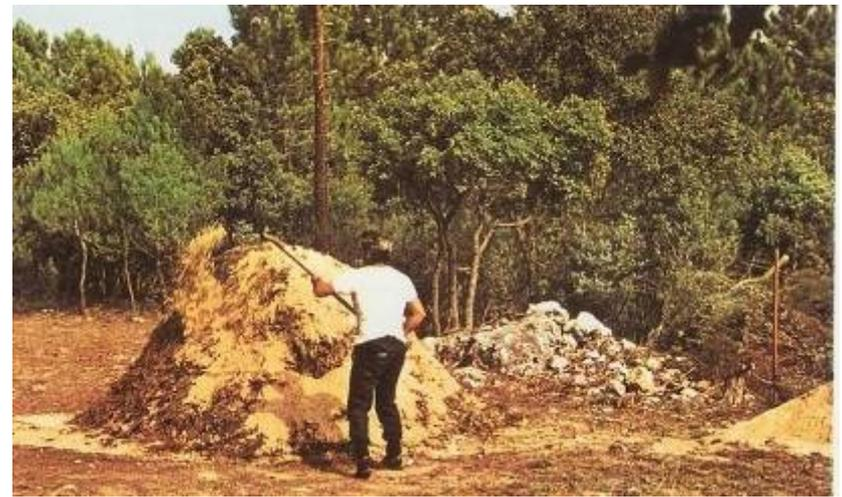

Still without pressing the heap down, spread a 2cm-thick layer of earth or sand or leaf-mould or even old compost over the heap with a spade. This operation takes a quarter of an hour

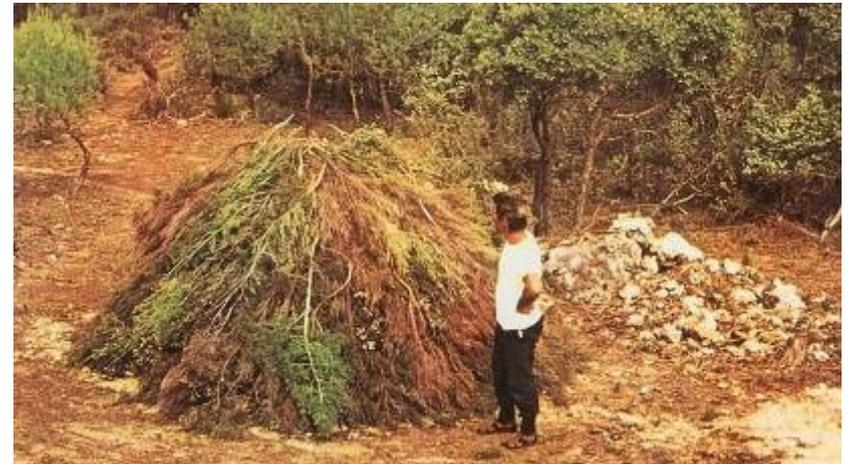

Here we are at the final stage. Place big boughs over the top as for the roof of a hut, so as protect the whole from rain, snow, wind and sun. this job takes one hour, taking into account the time it takes to collect up the big boughs in the forest. During the next few days, the heap will begin to ferment vigorously, and will sometime reach a temperature of 75°C; this is what you are aiming for. The various "aerobic" or "anaerobic" conditions (with or without the presence of air) are well-known, and, says Jean Pain, scientists have gone into them so thoroughly, from Brétignières to Demolon, Burgevin, Howard and Caspari, for the fabrication of artificial manure, that I do not intend to go into the process and complexity of them here. The essential thing for us here,

I think, is to record the excellent results obtained if the work is carried out according to Jean Pain's technique and respecting the times he indicates.

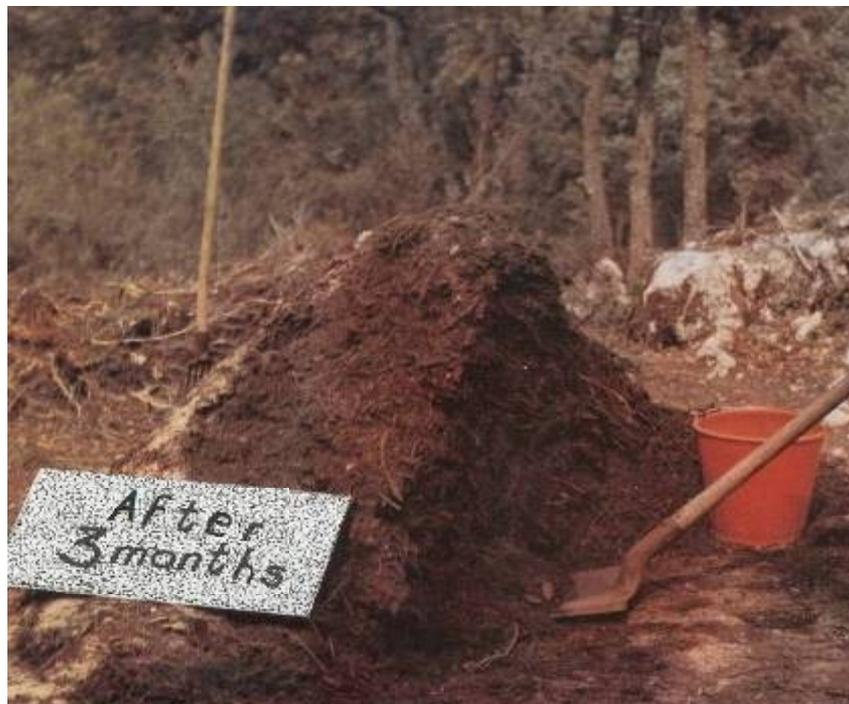

2. - AGRICULTURE : THE SOIL

CONDITIONS OF USE

Three months have gone by...

Here is the brushwood compost ready for use after 90 days ventilated fermentation. Notice the heap when is cut through – the coarseness of the vegetable matter, which is in spite of its appearance, has undergone a satisfactory and sufficient bacterial attack, so that it can now be used on the surface. Be careful to expose it as little as possible to sunlight, and to cover it with boughs or matting if you have to go away and leave the job for several hours.

« Obviously, » explains Jean Pain, « there is no time limit for its use. If you have no immediate use for it, cover the heap again carefully. A few months later you will have a lead-mould suitable for sowing, and for rare and delicate specimens in horticulture and floriculture, provided that the heap is turned one month before use and build up to its original size again.» It must be remembered that 90-days brushwood compost can be applied only on surface soil, and not blended into it, buried or incorporated. In the case of a different application, proceed as explained above that is by turning the heap over

again. This is indispensable. It would be a bad mistake to incorporate into the soil a product which was so coarse that it became foreign body in the ground instead of a food for it.

Indeed, such a mistake would inevitably lead to a “blockage”, a term which Jean Pain explain thus : « Introducing something like that into the soil would mean that the soil would be using most of its energy to “digest”, “absorb” and decompose it, at the expense of the plants which we would like to see grow and flourish. Worse still, since the compost is not “digested” in the ground in the same way as it is on the surface, that soil would most likely be in a pitiful state the following year, and even in some case the year after as well, since the ligneous matter, a component of the brushwood compost, takes this long to become sufficiently decomposed, and then, but only then, is it capable of enriching the soil. »

If, for practical reasons, one plans to use the brushwood compost as a fertilizer or humic improver, which can be incorporated as in the case of ordinary plantation, (cereals, fruit-trees, vegetables, vineyards, etc...) there is an easy test to determine whether it is possible or not : take one of the thickest pieces of wood out of the compost and try to crush it between your thumb and forefinger; if it resists this pressure, then the compost is not yet ready to be incorporated; but if it crumbles, that means that the state of decomposition is sufficiently advanced.

It can generally be considered that brushwood compost can be incorporated from the 9th month onwards, if the raw material used in its preparation has come from branches and boughs which are not very ligneous, that is that the biggest measures less than 1 cm in diameter.

If you are using compost from chipped and composted matter of a much bigger diameter, such as whole shrubs or young trees, (which make up the greater part of the brushwood obtained by firms who specialize in thicket clearance), it will not be possible to incorporate it for 18 months or even two years or more, depending on how well the brushwood has been chipped and refined.

(Report to [page 45](#) for quantities and conditions of use).

APPLICATION

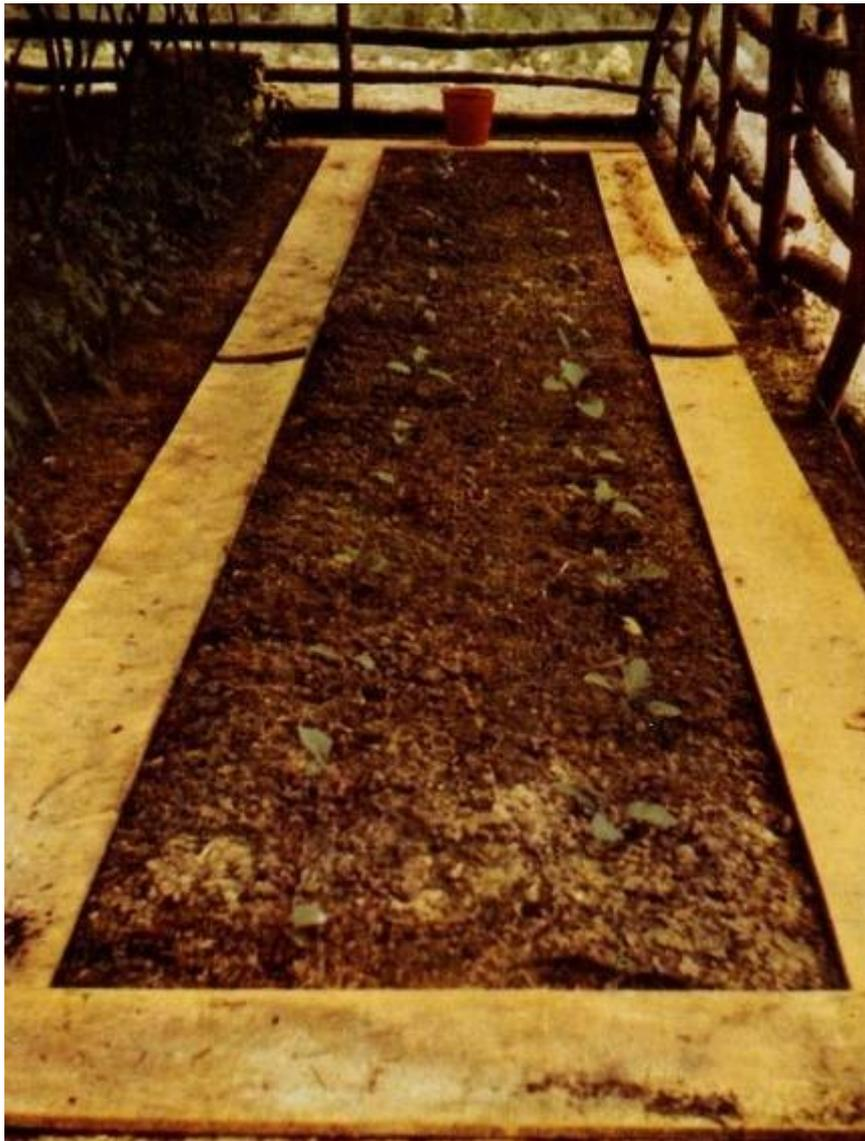

View of an aubergine plantation before brushwood compost was applied to the soil. Notice the planks which have been put down so that the gardener can walk to and from without flattening the earth. The planks will, of course, be removed as the job advances.

These young plants were bedded between May 5th and May 10th. Before that there was a spring crop of dwarf peas, and before the peas a crop of winter lettuce.

Now let us go back a little way. In November of the previous year, at the onset of the first frosts, the ground was cleared of its crop of water-melons. The last fruits and leaves were removed, and what remained of the compost and cover of the summer plantation, lightly hoed into the soil; then the winter lettuce were sown at once.

The nutritive organic matter of which the brushwood compost is composed is applied only once a year, at the beginning of the summer plantation, in a layer 7 cm thick. The summer plantation comes third in the cycle of the rotation of crops, the winter one coming first.

This rotation of crops is even more important here than in ordinary cultivation and it serves a double purpose; firstly, nothing of the natural elements employed is wasted, and secondly, the nutritive products which come from them are used in the best possible way : we know that leaf-vegetables need a lot of nitrogen, root vegetables potassium, and fruit-vegetables phosphoric acids. Let us not forget that plant matter from the forest is the only source used here, even for synthesis, where the use of water, that general solvent agent, without which we can do nothing, is necessary... and yet we do not water !



View of part of the summer plantation in May when the brushwood compost was being applied. Notice the props used that year : branches of arborescent heather.

Since Jean Pain advises against the use of shrubs like these for that purpose. He explains that when they are pushed into the ground there is a risk of their breaking suddenly and injuring the gardener.

Notice, too, that the tomato plants are tied very loosely to their props. « The young stalk must not be strangled » says Jean Pain. A week before this photograph was taken, the plants were pruned slightly to assist their growth. Sideshoots were removed which would otherwise be too much for the plant, except the one at the fifth leaf from the bottom, which incidentally, quickly grows into a stalk equal and parallel to the main stem, like a creeper. Then remove all the other sideshoots, except that at every tenth leaf. This should be done until September, and then after that the plant can be left to grow in its own way. All that has to be done then is to keep the plants tied back and pick the tomatoes.

It is because of this rather special way of pruning that Jean PAIN not only obtains suffrutescent plants 2.5 meters high, but also an amazing amount of fruit, sometimes 20 kg or more.

Before the tomatoes were planted, there was a spring crop of spinach. In winter the same area was used for carrots, and before that there was a summer plantation of aubergines.

Generally speaking, there are three lots of crops a year, in rotation, except when there are winter or spring vegetables which takes up the ground over two seasons.

SEEDS

For the sowing of seedling as a summer crop without watering, for example : carrots, turnips, lettuce, etc... the same procedure should be used as for plants : apply a layer of compost 7cm thick + a covering of 10 cm, but when you are ready to sow, draw back the compost and cover, sow the seed in the soil, and then, as the young plants develops, replace compost and cover. Never sow or plant in the compost itself; compost is the food of the soil, not of the plants.

IMPREGNATION : (additional information to [page 16](#))

It sometimes happens, through lack of time, that the gardener is unable to get the necessary volume together in a short time. In order to avoid its drying out, thus losing the benefit of impregnation, the dampened stocked matter should be protected by branches or straw matting.

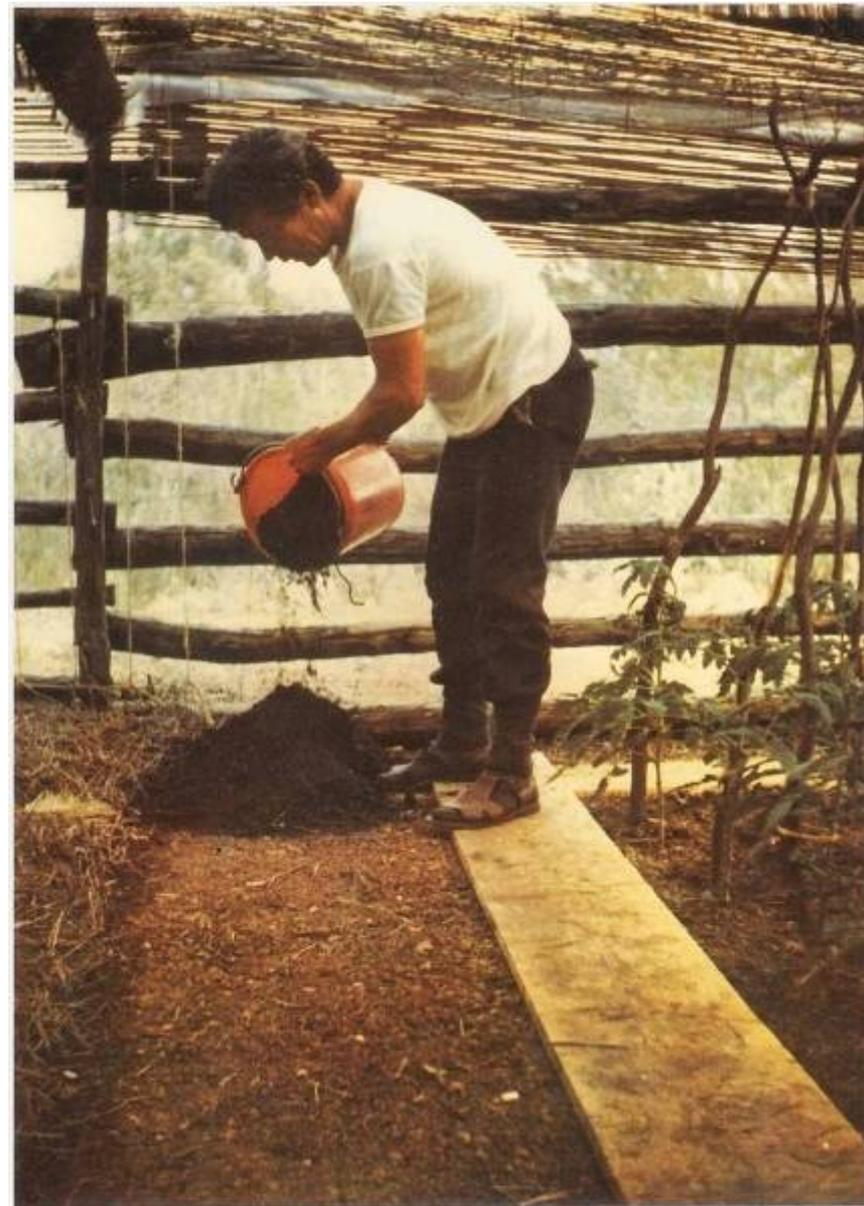

Application of brushwood compost; it is applied on the surface of the soil only, not incorporated. A minute later, Jean Pain will spread it over to form a even layer, 7cm thick.

« There is no harm in applying a thicker layer, if the height of the young plants permits », he says

It must not be forgotten, as Delomon has so well demonstrated in "The Dynamics of the Soil", that the soil is a living milieu.

One advantage (among many others) of using this compost and the life it brings with its intense microflora and microfauna is that it is of appreciable and irreplaceable value.

Immediately after this operation, Jean Pain will go off into the nearby forest to collect up pine-needles, so that the compost to be applied is as little exposed to sunlight as possible; it is better still to have the covering to hand.

Notice the canis used that particular year to give shade up to July.

Now I'll explain why the fence round the garden is so strong : it is well away from any spot which is lived-on or built-on; wild boar pass through it; there is considerable nocturnal activity round about : foxes, badgers, rabbits and other rodents, as well as the whole feathered tribe; in the daytime our own goat, etc.

No demonstration would have been possible without this sort of protection.

Obviously such a construction would not be justified in ordinary conditions, if the garden were near a house, for example.



Here is Jean Pain back again. He has been careful to take needles only from spots in the pine-forest which are very dense, thick and well-covered, always leaving a sufficient mattress to protect the soil.

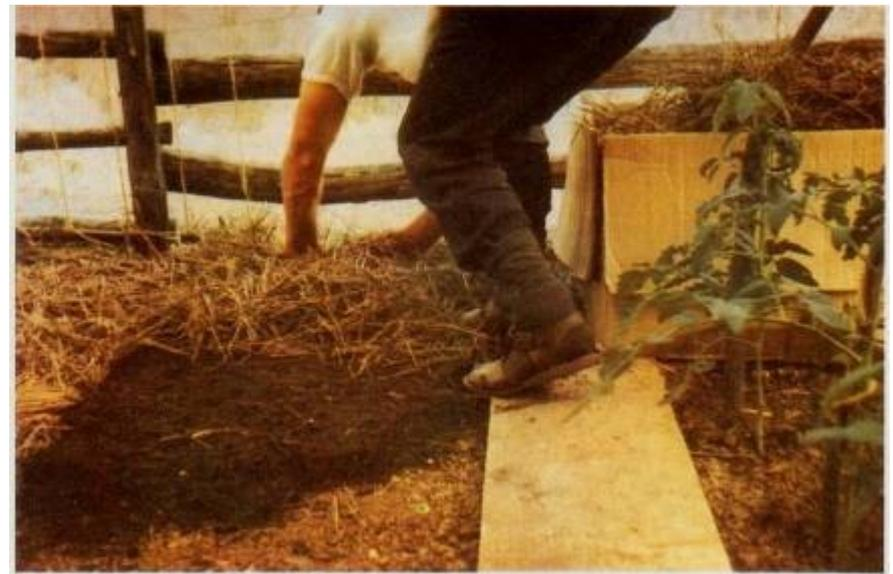

That year, for the first time, Jean Pain decided to use pine-needles for the summer covering, so as to show how useful this substance really is, still bearing in mind the fight against fire-spreading on the one hand, and on the other, to prove that it is not impossible to turn this substance which is considered to be nothing but a nuisance ("useless rubbish which sterilizes the soil") into a product which has a certain value when used in its technique.

Since then, a great many users have told us how satisfied they have been with a protective covering of pine-needles.

Indeed pine-needles are abundant, easy to gather up, voluminous because of their abundance, and therefore light for carrying. Another advantage is that air circulates very well in the mass. In conclusion, experience seems to prove that destructive animals such as rodents (e.g. rats and field-mice) do not care much for making their nests or homes in them, which is what sometimes happens when the protecting covering is of wild herbs, fine brushwood, straw or old hay.

Tests have also been carried out using bark from forest trees, notably in California; it is an interesting solution to the problem of evaporation, but the bark should be removed carefully at the end of the summer crop (which has had no water), in the same way as the pine-needles or whatever else is used as a covering and which does not decompose easily; this is important and must always be respected, so that the bark is not introduced into the ground as it is.



COVERING

Here we can see Jean Pain putting on the final covering for the summer plantation (a thicker layer this time -- about ten centimeters thick); this is essential for gardening without artificial watering.

« Indeed », explains Jean Pain, « not only will this covering prevent the water from evaporating from the soil and the compost, it will also, during the hottest part of the day, cause appreciable condensation at the top of the compost, and allow it to work intensely in the obscurity ».

He goes on to say, « Obviously, leaves, straw, hay or green grasses which have the not gone to seed, will bring about the same phenomenon. They will be even better, in fact, since the covering in pine-needles will have to be removed, inevitably, for the winter plantation which follows, whereas the covering of plant matter mentioned above can be lightly hoed into the soil at the end of the season (they will have diminished considerably by that time).

As for the pine-needles, they will, of course, go for composting. They should never be incorporated into the soil as they are.

Whatever vegetable matter is chosen as a covering to protect the earth and compost from evaporation, it will be important to make sure at the time of application that the layer is perfectly even and that there are no holes or badly filled-in gaps, especially at the foot of the young plants and round their stalks.

Indeed, a badly- or imperfectly-applied protective covering, for example if the paths and alleys are left uncovered (thinking that it is enough just to cover the actual cultivated areas), would let the humidity of the soil and subsoil out through the uncovered parts.

This is important, and particularly if, as in this case, the garden is small, that is about 100 m²



View of a part of the summer garden, unwatered, after application of brushwood compost and final covering of pine-needles.

Jean Pain has put the planks back, so as to avoid flattening everything during his frequent comings and goings to tie the tomato plants back. After that the planks will be removed until the plants have next to be tied back.

Notice the even green colour of the tomato leaves and of the young plants, the chlorophyll being evenly distributed over the surface of the leaves. There are no yellow or brown marks, streaks or spots which are symptomatic of various bacterial diseases or microscopic fungi, and which at this stage usually attack plants grown under normal conditions and with ordinary fertilizers.

At this point we can go back a little way to the last sentence of the previous page, and say something else about the area of the garden.

A great many people often those in the trade, market-gardener, horticulturists, etc..., asks if it would be possible to apply this method on a larger scale ; if all these protective measures would not involve a lot of expense with the labour force required, Jean Pain admits that he personally has not experience in large-scale market-gardening. However, mindful of economy and non waste, he set about doing some very precise calculations. He came to the conclusion that, in spite of the extra time called for at the beginning of the summer plantation, for applying the compost and covering, the gardener wins hands down by the fact that he does not have to water or see to the soil in any way for many months to come. Apart from these strictly material advantages, the quality of the produce, itself inestimable, must also be taken into account.

Finally, it should be added that, quite logically, the quantitative results must inevitably be equal, if not greater, over very large areas, since a micro-climate with a tendency to dampness is created when the area is bigger, in a dry region like our.

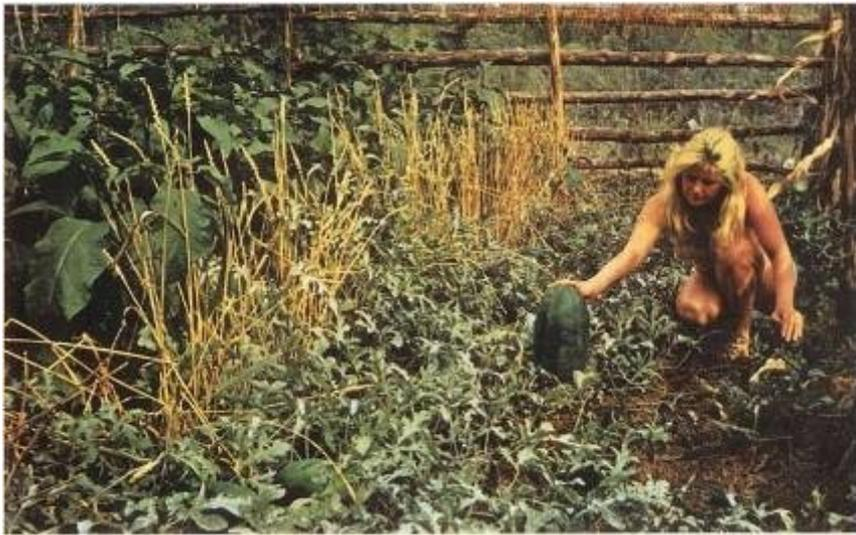

RESULTS

The author, in her husband's plantations, picking a water-melon weighing more than 6kg. Notice how strong the aubergine plants are. Their enormous fruits can hardly be seen for the dense foliage; in the background, hard against the wire-netting, CHAILLOTE plants, a tropical species of the pumpkin family, grown in Africa under this name and in the Caribbean under the name of christophine. Henri Sthele points out that in the ecological flora of the Caribbean its scientific name is *sechium odulum*, which means edible sechie. It is a good fruit-vegetable; it is sweet and can be eaten either as a salad or as a gratin.

In the middle foreground, a small crop of nearly ripe wheat (25th September). Jean Pain grew it for one thing to see how many stalks this variety of wheat grew (Talisman ,variety, fixed by Raoul Lemaire, a tender wheat, which makes very good bread, and a variety which is well- adapted to dry, hot regions). He also wanted to see how well the ear kept its grain in high winds (mistral), even at a very advanced state of maturity. I might add that the non-sifted flour from this variety of wheat and made into bread with spring-water (I have made some myself) produces a delicious, nutritious dynamic loaf. Notice too the total absence of disease on the plants, leaves and fruits (still without treatment of any kind).

The yellow which can be seen is due to natural ageing.

The last rainfall goes back to 27th June, that is 87 days without water.

The demonstration was brilliant. That year the covering was made of eagle ferns, cut down in the dales when they were still green.

Jean Pain explains : « Apart from the fact that this method of cultivation does away with watering, one also has the pleasure of noticing that one tedious task is dispensed with, and that is weeding; hoeing and raking are also done away with; none of this has to be done for more than five months, from May to November, which will enable the gardener to get on with other jobs, or even go away for several weeks, without the fear of finding on his return that his plantations have dried out to nothing or become over-run with self-sown plants. »



Jean Pain showing the inside of a water-melon, which, compared with the same fruit grown by ordinary methods, we found sweeter, more compact, firmer, and above all much more tasty.

This, incidentally, is one of the main features of vegetables and fruit grown with brushwood compost and without watering; in every case the fruit and vegetables are more dense, they have a better flavour and texture altogether, and they are less subject to parasite attacks. Nature would seem to have concentrated all her energies into giving the best of Herself; another sign : it often happens that the physiological characteristics of plants grown on this way are very like those of their wild counterparts, for examples, potatoes form after their plants have finished flowering, and leek-bulbs are well-developed like onions.



View of a tomato plantation on June 30th, with the first fruits ripening even before the sun-protector had been removed; the variety cultivated and adopted is the Saint Peter.

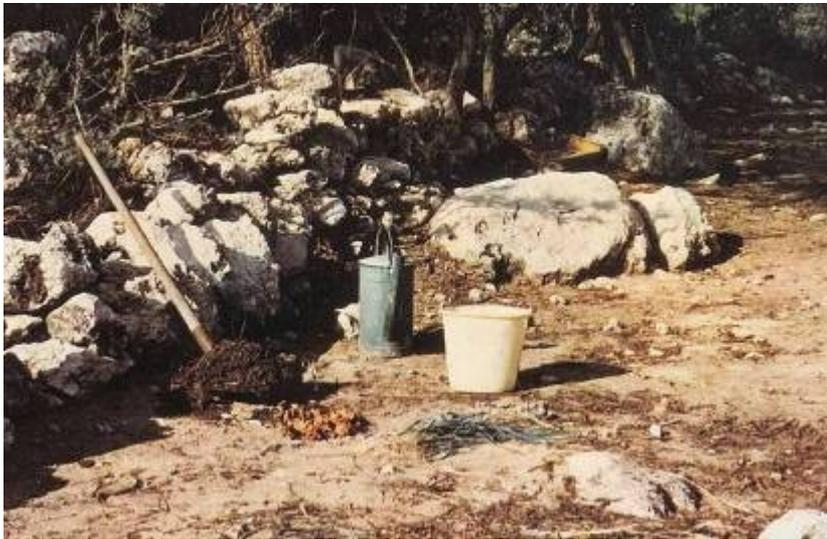

COATING

Approximately three kilos of brushwood compost, three kilos of red clay, three liters of water, all mixed together.

Jean Pain, at the height of the Provencal summer, 38C° in the shade, planting out a hundred young leeks, still without watering. He has prepared this thick solution to ensure that the young plants take. He will dip them into the solution to coat them, having cut the roots down to 1 cm and the leaves to 10 cm. This done, once in the garden, he will draw back the covering and quickly plant the leeks in the soil, through the compost, over an area of 4 m², then he will replace the covering immediately.

The clay bath recommended here has been well tried and tested by Jean Pain. He finds that it prevents the notorious worm from getting into the plant at

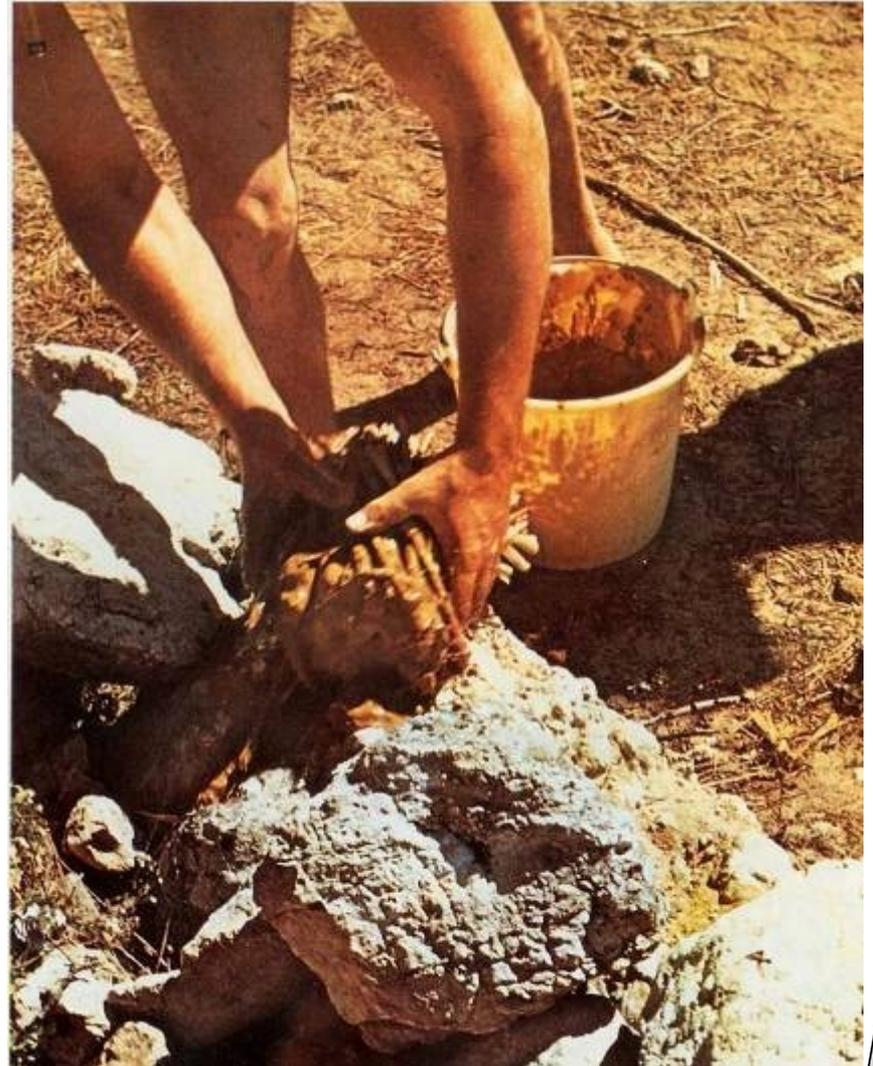

its most vulnerable stage This coating in no way hampers the growth of the plant; and anyway, it very soon get rid of it through cracks in the ground in the next few days.

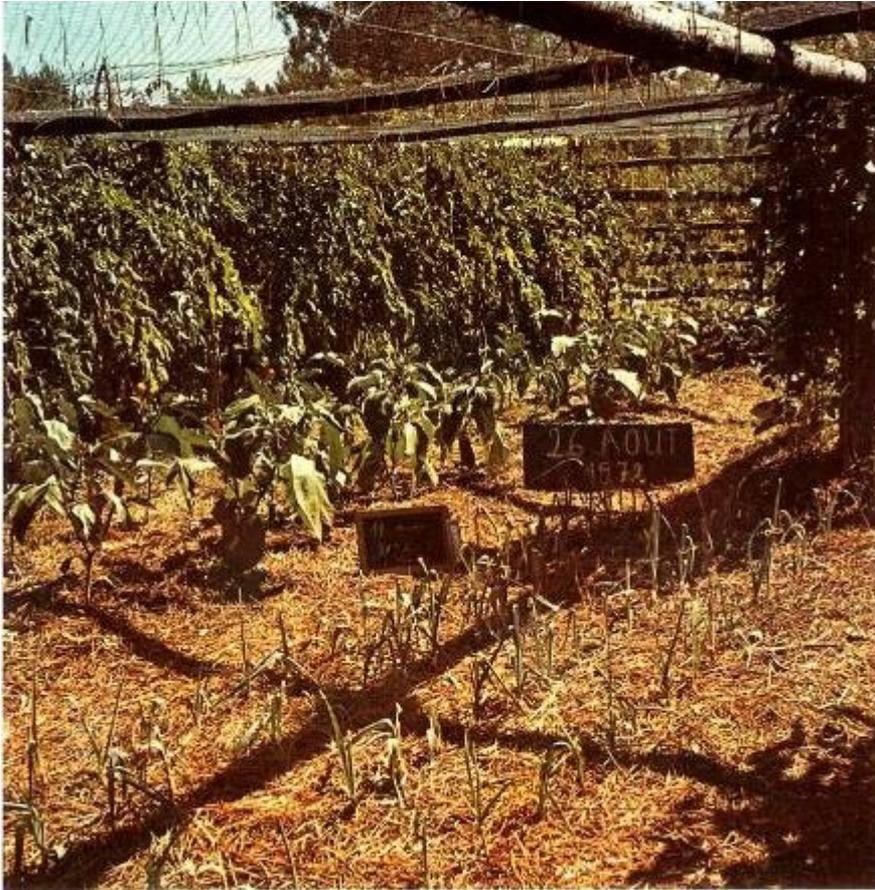

Part of the summer plantation at the end of August, a few weeks after the leeks were planted out; notice how well they have taken, and how the leaves have grown; notice, too, at the top of the leaves, what remains of the coating; it will soon disappear completely.

If the leeks have taken so well, and look so healthy, it is largely due to richness and quality of the incomparable brushwood compost; we insist on the fact that there has been no rain since the leeks were planted out..

The wilted look of the aubergine leaves is quite normal for the time of the year and at this time of day; every evening, though, however intense the heat has been during the day, the leaves will straighten up again like tulip petals, as if to quench their thirst in the night air.

Notice how strong the tomato plants are (on the left towards the back). They are already 1m 80 high, and their folial system is so well developed, that the fruit can hardly be seen for the leaves. Their average production at this period is over 6 kg. The huge surface of photosynthesis here is extraordinary, and largely surpasses the known norms, whatever the method of cultivation. It will be seen even more clearly in the following pages. On the right-hand prop you can see the stalks of the runner-beans (Contender variety) at the peak of production. They can be seen closer in other photos. Their average height, still at the same period, is 2 meters. At such a height, they use up and need an enormous amount of water. As for all the plants grown here, the very large leafy surface implies that there is considerable transpiration and yet they get no water except when it rains, and that is a very rare thing in Provence in summer.



View of a superb aubergine plantation on 21st September. Notice the quality of the foliage and the sturdy stalks, and still there is not the slightest sign of unbalance.

Average height at that date : 1 m 20.

Production : 5 aubergines per plant.

The growth, flowering and fructification will continue until the first November frosts.

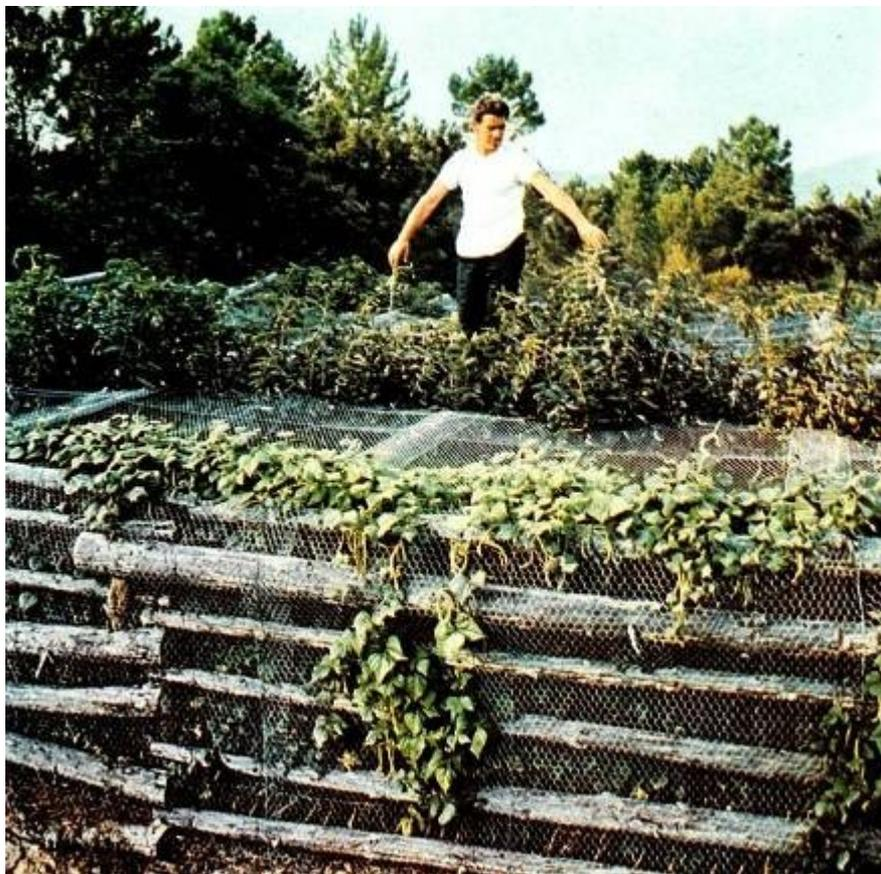

28 SEPTEMBER

Jean PAIN up on the garden roof, showing the height of the tomato plants :
2,50 m.
in the foreground, the runner-beans overrunning the protective wire-netting.

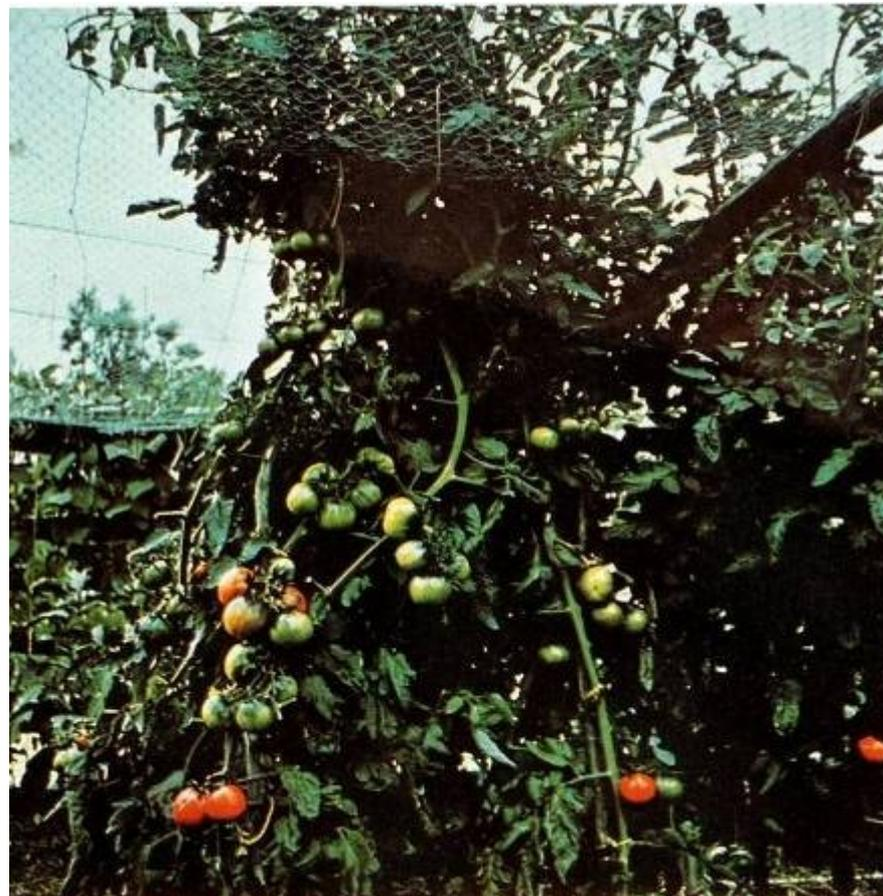

28 SEPTEMBER

A Saint Peter tomato plant in its third month of production



28 SEPTEMBER

AUBERGINE PLANTATION in its second month of production; in the background, the runner-beans.



Professor Henri Stehle, a French scientist particularly known in the United States en France for his work on Ecology and Botany, in collaboration with his wife.

I shall not remind you of all his titles and distinctions, too numerous to mention here.

Devoted to numerous philanthropic activities, on a social, cultural and scientific level, Professor Henri Stehle is, among other things, President of the Scientific Committee of the Regional Union for Provence-Côte d'Azur-Mediterranean, for the safeguard of Life, Nature and the Environment.

In his vocation as an ecologist (and one of repute), he is interested in Jean Pain's research, both in connection with forestal organization and from the point of view of agriculture and the protection of the environment..

Here we see Professor Henri Stehle with a few friends, giving us a brilliant exposé on the part played by bacteria and micorrhizes (microscopic fungi) and their action in the decomposition process of the lignin and cellulose, the principal components of the brushwood compost. Later he went on to explain to us the phenomenon of suberisation (or lignification) used by the plants cultivated here, so as to stand up to transpiration better in these particularly difficult conditions.

He also told us about the symbiotic effects caused by the association of certain plants with others or different species.

My husband and I express the wish of seeing men of worth and wisdom like this being widely heard in our day, and particularly by the younger generations for whom these elders are the veritable guides.



On the left, tomato plants in production; on the right, aubergine plantation.



Jean PAIN, at the end of the summer, appreciating the prodigious activity of the fauna under the covering, in the compost and in the soil.

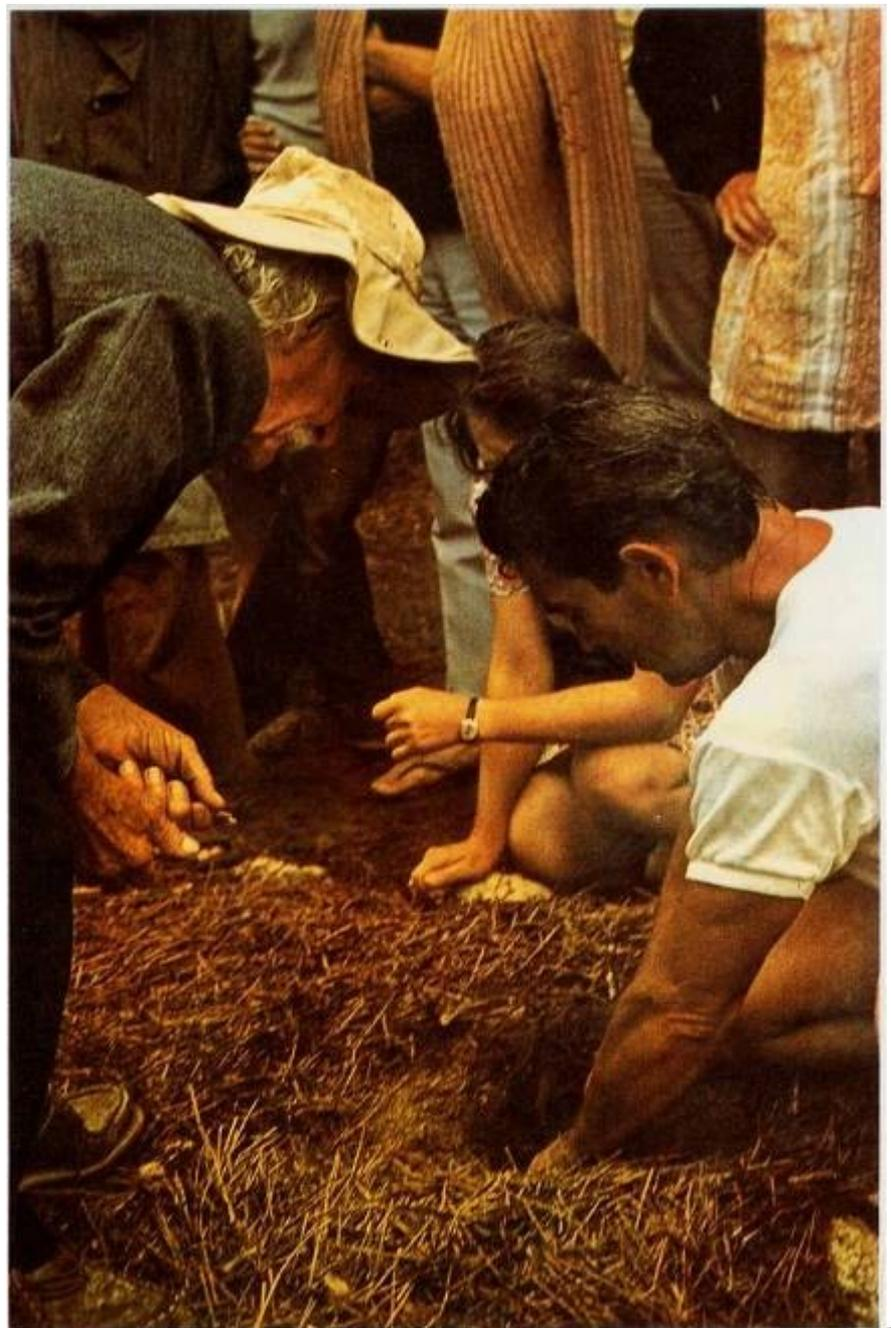

(See following page)

Victor Lebrun, who was secretary to Tolstoy for the last fifteen years of Tolstoy's life, was both a confirmed and competent agriculturist. He died at the age of 98, having cultivated the land and grown plants for more than sixty years, and during the last forty years of his life he became particularly interested in bee-keeping. In 1921, at the age of forty, he survived the great famine which killed twenty million people. He had to leave the land of Caucasus, where he lived with his family, in the exodus, for skies which were more clement at that time.

Apart from there being a mutual friendship between Victor Lebrun and Jean Pain, it was Victor Lebrun's experience of poverty and need which made him take such an interest in my husband's work, which he considered to be as important as the discovery of fire !

On the previous page he can be seen on a visit to our home with a group of friends. Jean Pain has uncovered the compost and is explaining the various phases in the evolution of the compost towards HUMUS.

We heard him repeat at each of these group visits, « HUMUS, being identical to LIFE, is, like LIFE, undefined and undefinable ».

Let us remember that the human race is incapable of manufacturing the least blade of grass. Let us then be content to play a humble part in its elaboration, being fully conscious of what we have a right to. Let us also pay tribute to that great scholar, WASKMAN (Nobel Prize for Medicine, 1952) for his admirable monograph on HUMUS, published in its second edition in 1938, grouping the results on 1311 original communications :

HUMUS : « A complex mass, dark brown in colour, consisting of amorphous substances which originate in the decomposition of plant and animal waste-matter by micro-organisms, in aerobic and anaerobic conditions, usually found in peat-bogs, soils, composts and humid cavities. Chemically, HUMUS is made up of various components which have resisted to a more advanced state of decomposition; substances produced by the decomposition of compounds; decomposition either by hydrolysis, or by oxidation, or by reduction; and from various compounds of synthesis from micro-organisms. Humus is a natural substance; it is a complex entity comparable to plants, animals and microbial substances go into its make-up. HUMUS possesses specific physical, chemical and biological properties which set it apart from all other natural organic bodies. By itself or by interaction with certain mineral components of the soil, HUMUS forms a colloidal compound, whose components are linked together by force of contact; this system can adapt to changes of conditions, reactions or humidity. The numerous activities of the micro-organisms of the soil play a large part in this system. »

The properties of HUMUS have been resumed by Waksman as follows :

« 1° HUMUS is dark in colour, brown to black.

« 2° HUMUS is practically insoluble in water, although part of it may go into a colloidal solution in pure water; HUMUS dissolves to a large extent

in weak alkaline solutions, especially at boiling point, leaving a dark-coloured extract, a substantial part of this extract precipitates when the alkaline solution is neutralized by mineral acids.

« 3° HUMUS contains a higher proportion of carbon than plants, animals' bodies or microbes, the percentage of carbon lies somewhere between 55% and 56%, and often reaches 58%.

« 4° HUMUS contains a great deal of azote, often between 3% and 6%. The percentage of azote can often be inferior to these figures; in the case of marsh peat at high altitudes, it can drop from 0.5 – 0.8%. This percentage can equally well be higher, especially in layers underlying the soil, where it often reaches 10% or 12%.

« 5° HUMUS contains carbon and azote in relative proportions of about 10 to 1. It is thus particularly indicated for coastal ground. The proportions varies a lot according to the nature of the humus, the stage of decomposition, the nature and depth of the underlying soil, and the climatic conditions and various other conditions of formation.

« 6° HUMUS is not static, it changes, since it re-forms over and over again from plant and animal waste-matter, and it is constantly changing through the action of micro-organisms..

« 7° HUMUS provides the source of energy for the development of various groups of micro-organisms, and during decomposition gives off a continuous flow of carbon dioxide and ammonia.

« 8° HUMUS is characterized by its great capacity for exchange and combination with the other components of the soil, its capacity for water-absorption and expansion. It is also characterized by other physical and physicochemical properties, which make it one of most precious parts of the substratum, bringing life to plants and animals alike. »

A word about the use of young HUMUS in the form of brushwood compost. It will be interesting to mention here that experiments have been carried out applying small quantities of compost and then watering; fed in this way, the base-soil was seen to increase its capacity of water-retention considerably, thus making it possible to water less frequently whether by irrigation or spraying.

Our experiments in cultivation without watering in green houses have shown us that is not possible, the atmospheric climate being different, and the soil-air, air-soil exchanges not being the same as in the open air.

Many years have passed since the first edition of this book appeared on May 1st 1973, years of further experiments, applications, lectures, diffusions and adoption of this method by thousands of adepts, gardeners and agriculturists, all over the world. There have been few failures, and those, in most cases, have been due to insufficient care during the preparation of the brushwood compost

-- it has usually been insufficiently or unevenly humidified.

To palliate the deficiency, and as follow-up to our earlier efforts, the brushwood compost industry was born; it was hesitant, having no real references to go on at the time, but today it offers the user just one product in three different forms :

- 1- chipped brushwood,
- 2- brushwood compost which is freshly elaborate or which can be used as a covering,
- 3- brushwood compost which can be incorporated into the top 10 cm of soil. (N.B. see [page 21](#)).

It is the use of this last form that we shall discuss below :

Here are the quantities Jean Pain advises you to use :



1°) VINES AND FRUIT-TREES :

Quantity when planting : for 100 m² (1 are) 100 Kg, i.e. 10 tons per hectare, lightly scratched, harrowed or hoed into the top 10 cm of soil – 50kg at the foot of each tree after it has been planted and the hole filled in. Density of plantation : 200 trees per hectare. To replenish the soil, every autumn apply, for 100 m² (1 are), 10 kg, i.e. 1 ton per hectare, provided that the soil is not disturbed any more, but covered over in the spring. The plantation should be followed by permanent grassland, and the grass mowed twice a year, once at the end of June and again at the end of October.

WARNING ! It is most important to mow or cut the grass right up to the foot of the tree or vine, taking care not to leave any stalks, which could harm the tree or vine (this especially applies to young plants).

CEREALS



2°) CULTIVATION OF CEREALS, LEGUMINOUS AND OLEAGINOUS PLANTS (WHEAT, BARLEY, OATS, RYE, CORN, SOYA, COLZA, etc.)

Quantity at the beginning of cultivation or conversion : for 100 m², 400 kg, i.e. 40 tons per hectare.

Then, in the years following, (rotating the plantations, of course), for 100 m², 50 kg, i.e. 5 tons per hectare, provided that all the left-overs from the harvest are mown back into the soil.

See [page 47](#)

ON GOOD SOIL : apply the above quantities.
ON MEDIUM SOIL : double the quantities advised.
ON POOR SOIL : treble the quantities advised.

GRASSLAND



3°) PERMANENT GRASSLAND FOR GRAZING OR MOWING

Quantity required for sowing at the start : for 100m², 300 kg; i.e. 30 tons per hectare.

Quantity required when applying brushwood compost for the first time on existing grassland which is being converted but on which there are still plenty of leguminous plants (all varieties of clover, vetch, sainfoin, bird's foot trefoil, hop trefoil, etc.) – for 100 m², 100 kg, i.e. 10 tons per hectare. Then, the years following that, 20 kg per are, i.e. 2 tons per hectare, still provided that the autumn growth is mown back into the soil.

See page 47

- ON GOOD SOIL : apply the above quantities.
- ON MEDIUM SOIL : double the quantities advised.
- ON POOR SOIL : treble the quantities advised.

4°) ORDINARY VEGETABLE AND FRUIT CULTIVATION, including POTATO CULTIVATION

These types of cultivation are much more demanding in humic and organic matter : :

CONSANT ANNUAL DOSE : for 100 m², (1 are) 500 kg, i.e. 50 tons per hectare.

It stands to reason that there, too, all the left-overs from previous plantation should be put back into the soil, preferably after composting..

ON GOOD SOIL : apply the above quantities.

ON MEDIUM SOIL : double the quantities advised.

ON POOR SOIL : treble the quantities advised.

GOOD SOIL : for example, dales, low-lying ground, land for vegetable cultivation – various methods of cultivation, still has a good granular structure and normal proportion of humus : minimum 3%.

MEDIUM SOIL : for example, clay-chalky plains common on Mediterranean areas which have not been fertilized organically for a long time.

POOR SOIL : for example, terracing, « restanque », or hillsides which have been left uncultivated, but which are not wooded or bushy, in fact fallow ground with very little vegetation.

Of course the topographical situation of these soils and climate should also be taken into account.

IMPORTANT : The brushwood compost provides the Soil's nourishment. It is sufficient in itself and in no circumstances is the application of any « complementary » fertilizer necessary.

We ask you to read this little book carefully and follow the advice given throughout, so that you, too, may obtain results which are just as exceptional as those obtained by Jean PAIN.

AGRICULTURE IS A DIFFICULT ART

INDUSTRIALIZATION OF BRUSHWOOD COMPOSTING

Here the work is different from manual composting. It can work on a planetary scale and it can claim to refertilize desert soils which until now could not be considered for cultivation.

1°) THICKET CLEARANCE : a delicate operation in which one must take into account the very fragile ecological balance of forests; it is a job for experts and foresters.

Once again, our aim is to safeguard the woodland.

The forest must not be destroyed, but kept under and cleared.

Raw material is abundant and is renewed at different rates, according to climate and soil; often there are more than 50 tons of it the hectare. The brushwood obtained from thicket clearance consists chiefly of small trees and shrubs cut down whole, except those which are left to grow to adult height, of course.

2°) CHIPPING : the size of these trees, sometimes more than 10 cm in diameter at their base, calls for heavy, powerful machinery to chip them. There are several types of chipper. We favour the one which produce shavings rather than shreds; on this depend the quality and elaboration of the compost; it is better to have a long, thin fragment than a short, thick one; the water will penetrate better, therefore more quickly. (ideal thickness : 1 mm). See Jean PAIN chipper-refiner, [pages 57, 58, 59](#).

3°) IMPREGNATION : 1 m³ of ideally-chipped brushwood can absorb and retain 700 liters of water over a period of three days. Impregnation is achieved as the heap grows by watering at least every 10 cm (or, better still, every 6-8 cm) until saturation point; dig a gully at the bottom of the heap to collect the excess water; this drained-off water is recycled periodically– it is sprayed over the heap by an automatic pumping-circuit. The size of the heap can vary, but to make the following explanation clearer, we will take as our example a heap of approximately 50 tons : 6 m long – 5 m wide – 2.5 m high = 75 m³. This 50 tons experimental heap represent both the amount of plant matter obtained from an averagely bushy forest (35-40 tons of brushwood) and the average dose of humic manure for one hectare of land used for cereal-growing. The density of the brushwood compost varies according to its state of elaboration; the chipped brushwood has a density of approximately 0,3. after humidification, 1 and more. Ready for use, 0,6--0,7. supposing that this heap is intended for ordinary agricultural use, the compost will be ready from the 18th month of fermentation onward, always provided that it is turned at least a month before use, and that the « crushing test » between thumb and forefinger is positive. (See [page 21](#))

Care should be taken to maintain a sufficiently high ratio of humidity (40%--50%) at all times throughout the whole of the elaboration period, if necessary by an automatic watering system.

3. - ENERGY : POWER

PRODUCTION OF ENERGY IN CALORIFIC FORM (hot water) and uses : heating, domestic uses, etc... or BACTERIAL ENERGY.

During the course of fermentation the brushwood compost gives off quite an amount of heat : 60°C on average. This heat is due to the proliferation and activity of bacteria. Here again, I do think it is worth going into a lot of biochemical explanations (this little book treating the essential points), the important part being the application. Our experiment have shown that a 50 tons heap is capable of producing hot water at 60°C (it entered at 10°C) at a rate of 4 liters per minute, for 6 months, without this interfering with or harming the compost; inside the heap, a series of plastic tubes joined together to make one coil.

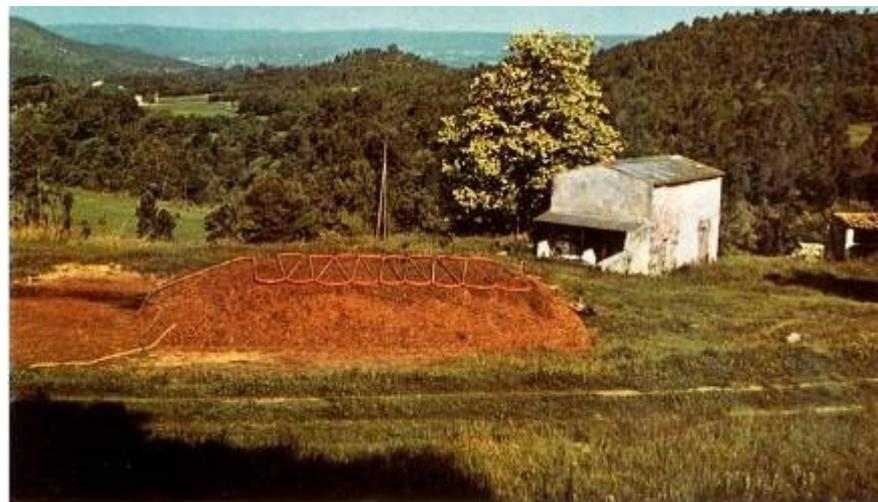

Photo n° 1

The coil can be placed horizontally (photo n° 1) or vertically. After many attempts, we noticed the following things :

- 1 – that the horizontal position was easier, but that there were a lot of problems when it came to dismantling it. (because the heap was compressed) ;
- 2 – that the vertical position called for greater precision at the set-up, but that it was more rational, and especially where large volumes were involved : 200 tons or more; set up like this, it is easier to add or remove compost.

In every case the tubes must be connected carefully, otherwise a leakage is possible, which is a nuisance and difficult to detect when it is inside the heap.



Photo n° 2

PUTTING INTO OPERATION :

For the hot water supply for sinks, baths, showers, laundry, etc., either the source of cold water can be connected to one end of the coil with a tap at the other which can be turned on or off as required (photo n°2), or else the water can be heated by means of a coil passing through a tank, which in this case will be connected to the supply network.

For the heating of buildings (photo n° 3, see following page) houses, annexes, greenhouses, etc., the user has two possibilities :

- 1 - the thermo-siphon.
- 2 - the accelerator - circulator.

The first formula calls for good notions of heating when putting into operation; the heap of brushwood compost, which is the heat-producer, will have to be placed at a lower level than the buildings which are to be heated : on the other hand, this solution requires no other source of energy.

In the second case, the position of the heap is not important, the thermo-siphon system being replaced by the accelerator-circulator; an external source of energy is necessary, but the calorific output is higher and large installations can be satisfied more rationally; a large number of radiators, public-buildings, community centers, big swimming-pools, etc...

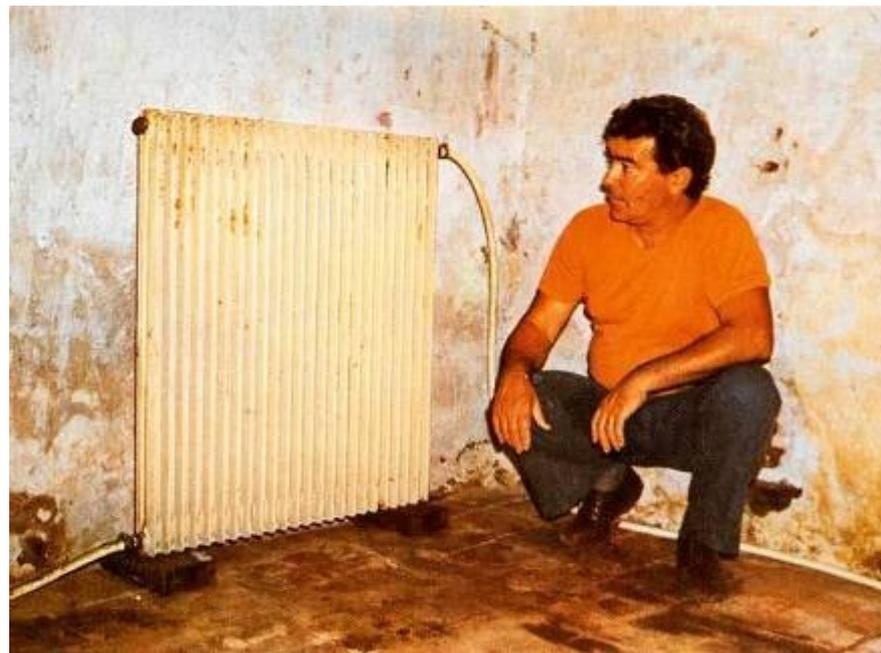

Photo n° 3

Our 50 tons test heap is perfectly capable of heating a 5-roomed house of 100 m² or so, and of producing enough hot water for its occupants for at least 6 months.

3. XI. 76. As I write these lines, one compost heap, 120 tons in weight and more than 18 months old, is still at a temperature of 58°C, which would appear to mean that the same heap would be capable of heating buildings for 2 winters and throughout these 18 months produce enough water for the occupants of these buildings. Installations designed to demonstrate this possibility are being experimented in our region.

POSSIBILITY FOR THE FUTURE OF PRODUCING ENERGY IN THE FORM OF ELECTRICITY FROM THE HEAT GIVEN OFF BY BRUSHWOOD COMPOST (still in experimental stage).

For several months now, Etienne Bonvallet and I have been working on a Bio-Thermo-Electric-Plant (Photos N°s 4 et 5), see following page, by applying Carnot's principle.

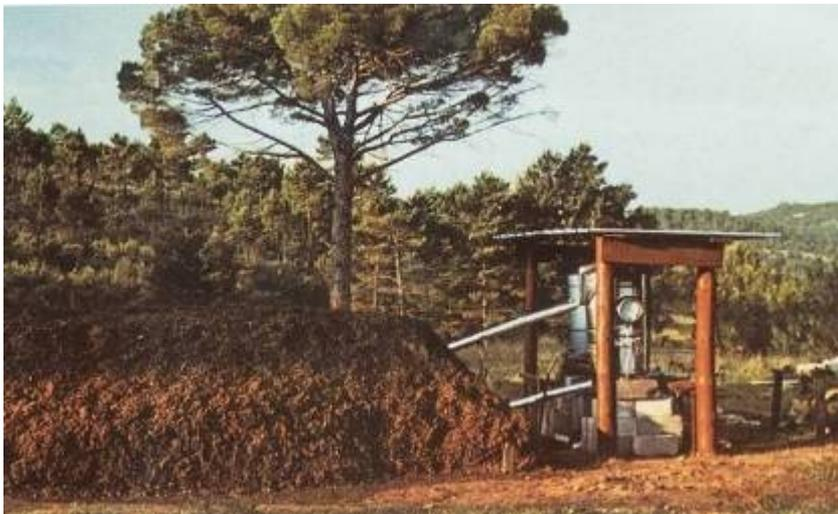

Photo n° 4

5. XI 76 FIRST BIO-THERMO-ELECTRIC PLANT

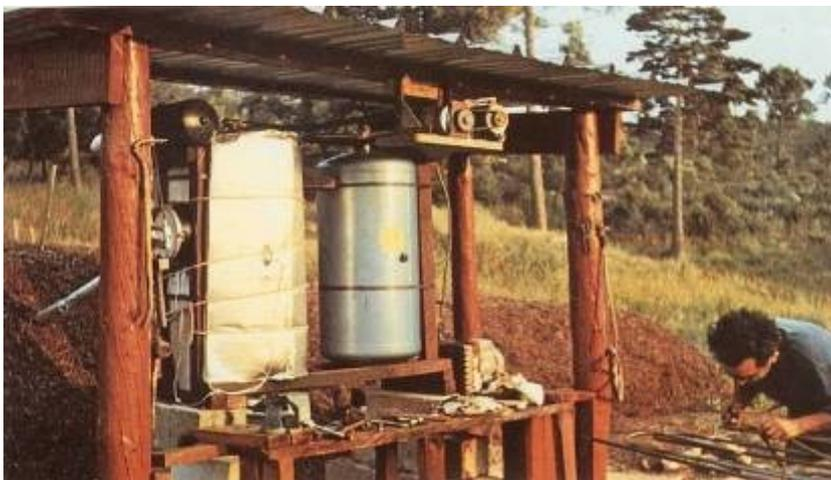

Photo n° 5

PRACTICAL CONCLUSIONS : looking through this book, the reader will have gained some idea of the astonishing possibilities offered by the rational use throughout the world of brushwood compost, that generator of fertility and of domestic benefits. Among these possibilities is that of giving back to the forest, in compost form, the thickets which have been taken from it for its own good.

Indeed, to counterbalance the expenses involved in the various jobs leading up to composting, in return one has energy in calorific form which covers all the costs.
It's worth thinking about.

The very latest discovery in brushwood compost heating :

It concerns the way in which the heat captors are placed inside the heap on one hand, and on the other, the new shape of the heap itself. It is now cylindrical.

DIAGRAM N° 1 : using chipped brushwood, build a round tower : diameter : 1,50 m – height : 3 m

DIAGRAM N° 2 : a semi-flexible black polyethylene tube is wound round the tower, starting 0,70 m from the ground and moving upwards, leaving an interval of 0,20 m between each spiral until there are 10; the tube should be kept taut while being wound round so that it does not slip; size of tube : 28 x 32 mm; the upper and lower points of the tubing, A and B, should of course be secured, so that it does not lose grip.

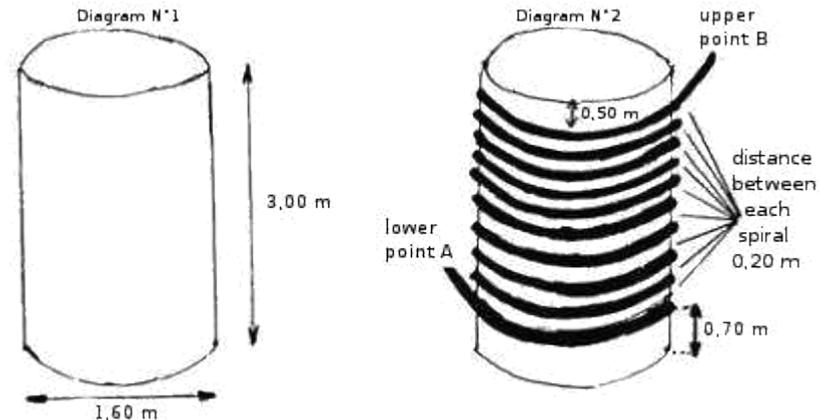

A further layer (50cm thick) of brushwood compost is added to the central tower to a height of 3,00 m (DIAGRAM N°3) then the operation is repeated, (DIAGRAM N°4), the tube is put into position, the chipped brushwood added as many times as desired, depending on the volume of greenhouses, buildings or water-tank there is to be heated.

This operation is illustrated by the photographs on page 55.

Diagram N° 3

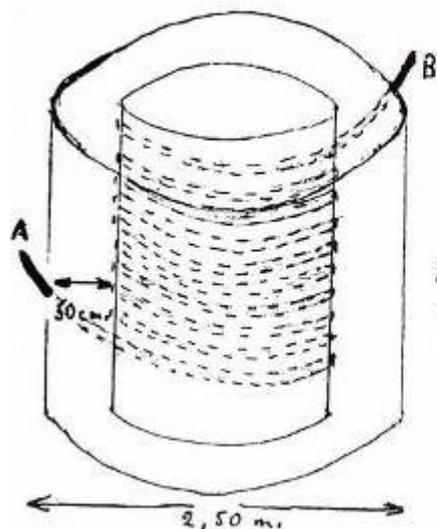
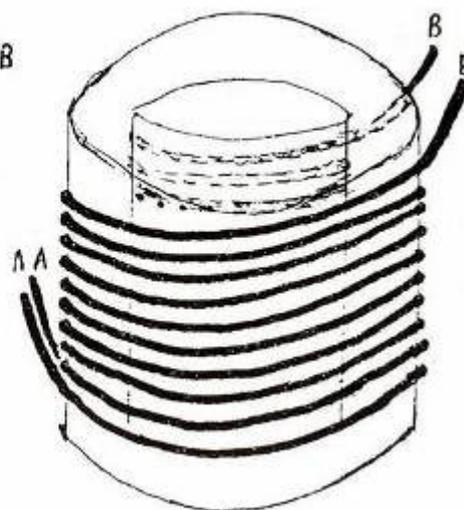

Diagram N° 4



Once the operation is over, the points A are brought together into one single pipe, which is connected to the radiator circuit in its turn; the same thing is done with the upper points B. Thus, inside the finished heap there can be as many spirals as needed, parallel to one another and collecting all heat diffused by the fermenting mass.

It will be found that dismantling all this will be considerably easier than for other type of heap. Just disconnect the collector pipe from the radiator circuit, take the upper point B of each spiral and unwind the tube, reversing the setting-up operation; be careful to evacuate the compost as you take the heap down, even if only to give yourself more room..

Note that a heap of brushwood compost taking up 23 m² of ground, for a weight of 16,800 kg, and equipped with three coils for a total diameter of 5 meters, is capable of heating, in our region, a double-walled tunnel greenhouse of an area of 105 m² and of a volume of air of 211 m³. (See [page 56](#)).

Author's note :

We are continuing our research into the production of ENERGY by the distillation of brushwood and the uses of the distillate as liquid fuel.

We have resumed our experiments, interrupted for several years through lack of time, on animal food (for goats) made from the flour of selected brushwood.



Setting up of the collector, which will ultimately be placed inside the heap.



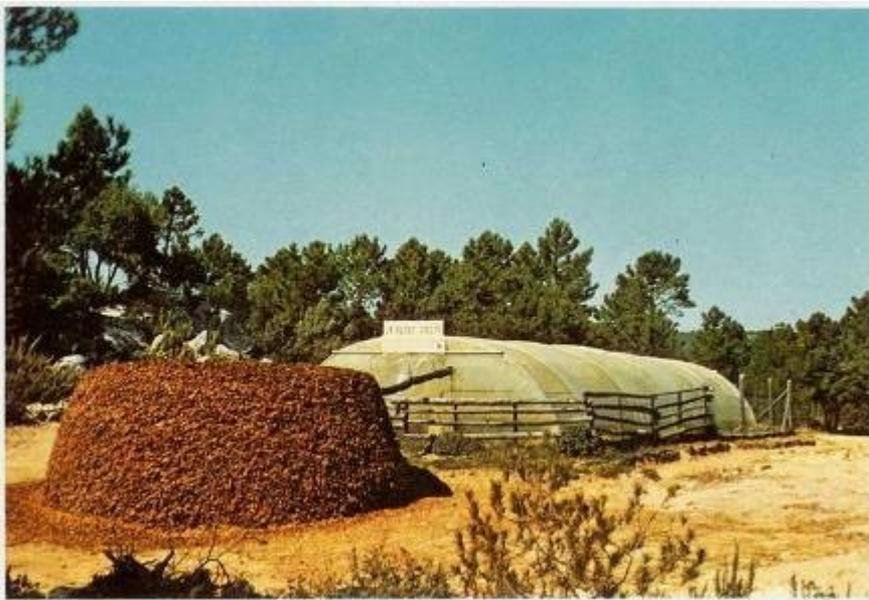

The brushwood diffuses its heat by means of an umbilical cord of hot water.

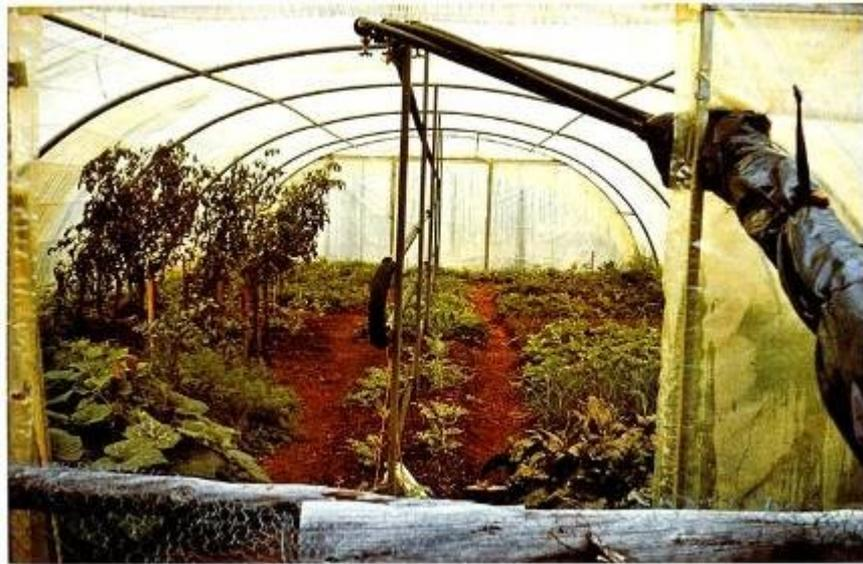

... inside the greenhouse, where vegetables and fruit grow in spring-like conditions.

A small chipper... With big capabilities !



Owing to a big demand for the equipment adapted to brushwood chipping, we decided to build the first Jean PAIN brushwood chipper.

The system is original : brushwood is fed into the machine and by means of an action of mobile blades and a counter action of fixed blades, it is reduced to fragments ideal for use in our methods. Here is the chipper in action : kept constantly fed, it is capable of absorbing 30 m³, this giving about 3 m³ of chipped brushwood per hour.

The diameter of the biggest branches is limited only by the power of the motor, and can be anything up to 15 cm for a 100 H.P. motor.

The chipper is compact, sturdy and relatively noiseless; it weighs approximately 200 kg; it can generally be fixed on to the 3-point power plug of a farm tractor or a public works vehicle.

To enable really fine chipping, simple accessories have been added to the main body of the machine :

1. – a second hopper fixed on to the supply-hopper, above which there is a storage element which holds about 800 liters with two agitators to assure the flow of the chipped matter ;

2. – a propeller and a multi-directional « neck » for the recycling and evacuation of the refined matter..

Thus equipped, this machine, which took fourth prize at the Mountain Agricultural Show at Grenoble in 1978, provides a reliable agricultural accessory, and can be used either on a farm or by a forestry firm. Weight of the complete equipment : approximately 1 000 kg

Now let us see how the machine works, with the help of pictures :



Step 1 : The thickets and branches are introduced into the supply-hopper; they are seized by the sharp fixed blades of a rotor which does an average of 1 000 revolutions per minute; at the same time, they are hacked by the counteraction of the sharp fixed blades of a stator which is in line with the rotor; the fragments obtained from these two conjugated actions are then immediately taken over by the blades of a propellor fixed to the extension of the axle; the centrifugal force then sends these fragments through a mobile « neck » (which is multi-directional and pivoting) into a storage element in the top part of the machine.

Step 2 : Once the storage element, which holds about 800 liters, is full, the refining begins. The chipped matter passes through a trap-door at the bottom of the storage element and perpendicular to the rotor, and resumes the same cycle already described for as long as the operator wishes (the flow of the chipped matter is assured throughout by the action of the two superposed agitators inside the storage element)

Step 3 : the final stage – when the operator considers the chipped brushwood to be fine enough, all he has to do is move the evacuation « neck » round in the direction he wants, and then it all out.

Conclusion : the final product thus obtained can then be composted to make agricultural humus, recovering the heat produced, or else be used to product methane gas, or for distillation, or even for animal fodder..

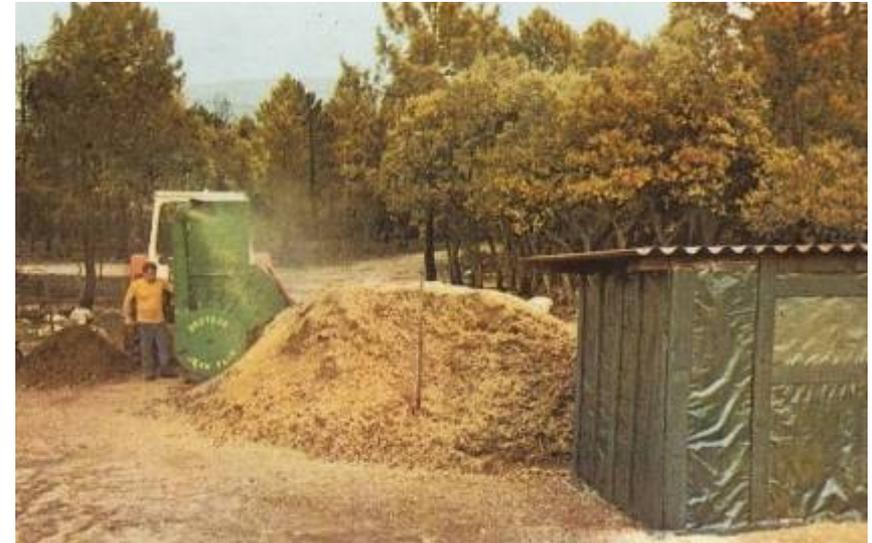

Let us at this point consider the way (perhaps the easiest one) in which we recover the heat produced by the fermenting brushwood compost : we do so by means of reheated air; take the example of this forest shed, whose inside volume is 12 m³; for the purpose of the experiment and demonstration, 12 m³ of chipped brushwood were prepared; such a system is primitive and not very costly; the air will circulate through a pipe, which can be made of rustless stove pipes. They should measure 12,5 cm in diameter and be spaced out at suitable distances inside the heap : see following photographs;



An opening was made at the bottom of the shed, at ground level, and the sections of piping fitted...

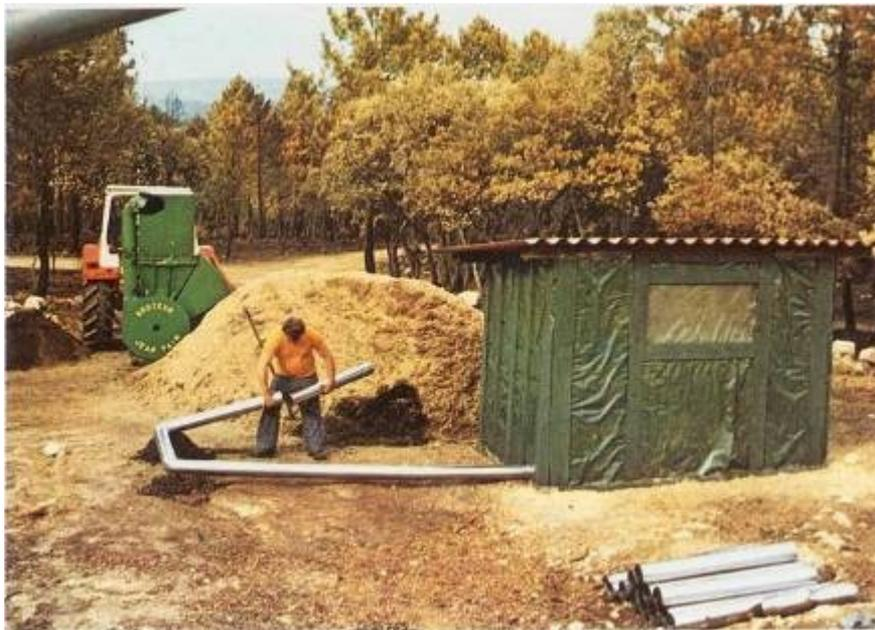

... Into one other and fixed together by elbow-shaped bends...

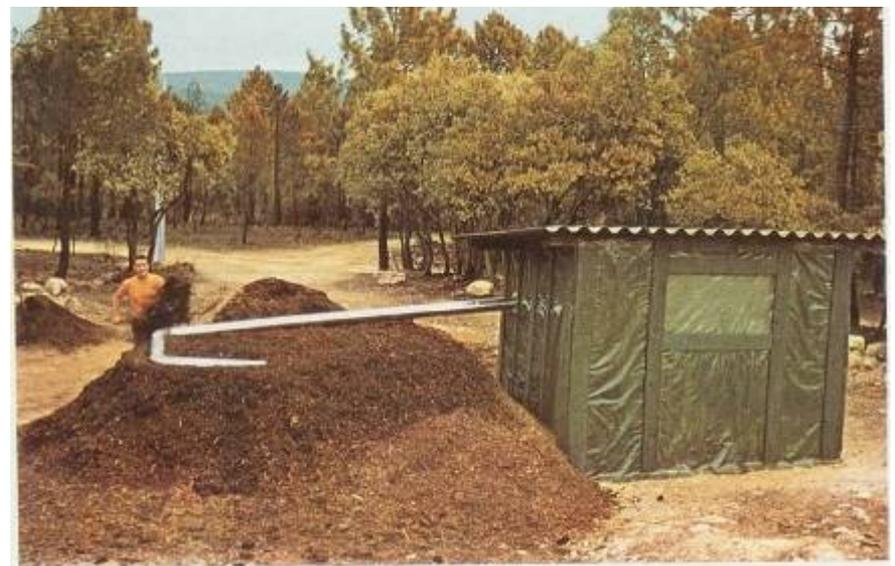

...at three levels, the difference between the lowest and highest points being approximately 1,20 m, the highest point passing through the wall of the shed by a trap-door made specially for it.

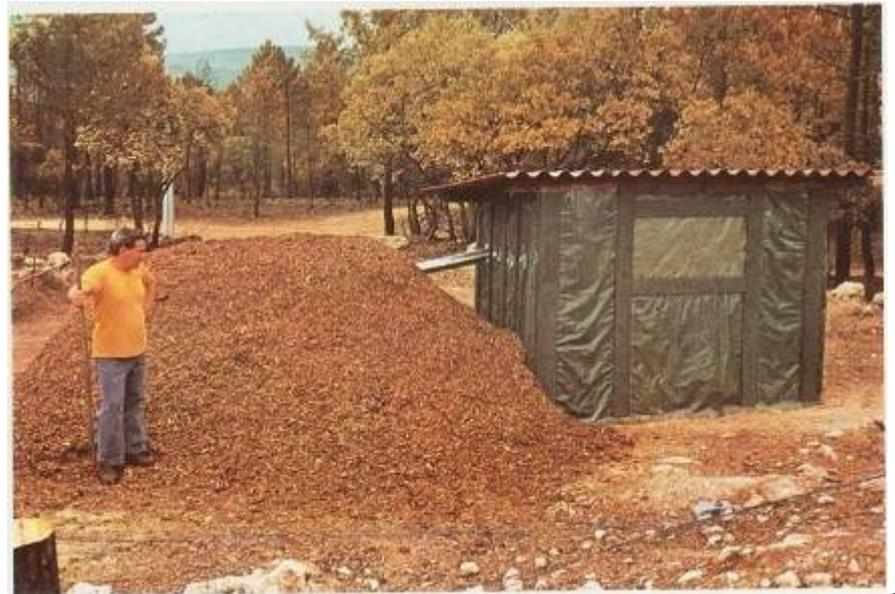

During the following days and throughout the eight months that the experiment lasted, temperatures recorded inside the shed, which was not insulated, reached as much as 52° C.

BRUSHWOOD GAS, THE ENERGY OF TOMORROW

Here again, as for the fermentations, the different processes of producing gas by methanogenesis are well-known and have been recorded by scientists and pioneers such as Ducellier, Isman, Fry, Sauze, etc... in many excellent works; so we shall simply examine the practical possibilities (which are enormous) of production offered by the treatment of brushwood in closed vessels.

After many experiments, we find that 5 kg of brushwood finely chipped in our machine are able to produce 1m³ of gas at atmospheric pressure, which works out roughly at 5 500 kilocalories or 6 deciliters of fuel-oil that is just under half a liter of BEST-GRADE petrol.

This gas, properly purified by an extremely simple process, can be compressed and then used for standard internal combustion engines; this is an interesting usage for the autonomy it brings, although it does mean modifying standard carburetors, in order to obtain the adequate dosage of gas mixture. (See result on [page 64](#)).

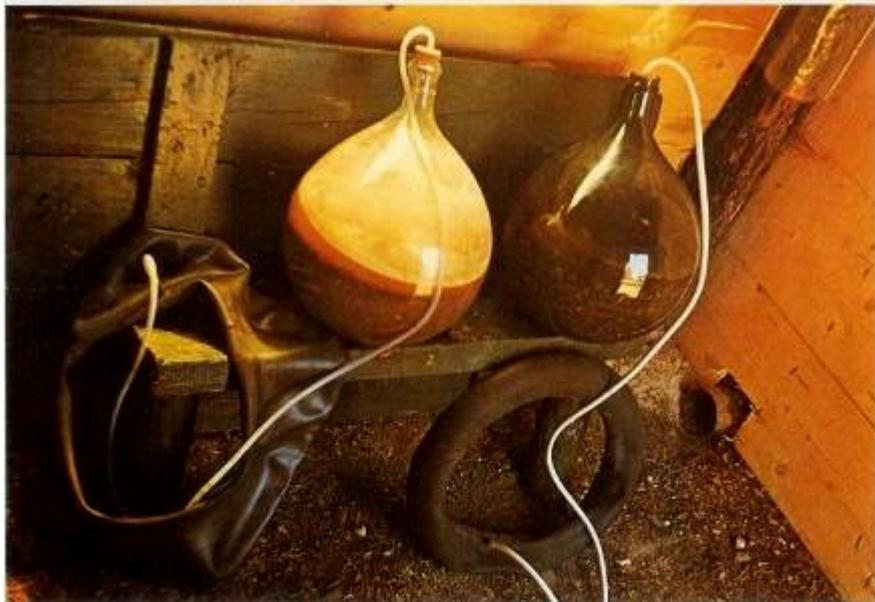

The photo shows the rudimentary apparatus which enabled us to make some conclusive tests; a miniature piece of apparatus identical to one we saw at John Fry's at Santa-Barbara in California.

These transparent glass vessels enable us to control the progress of the substance being produced.

Ordinary inner tubes from car wheels indicate the quantity of gas produced when they are full; finally, a spout made from the casing of a pen allows one to see the quality of the gas obtained when a flame is put to it. See photo below.

It should be remembered that, having obtained gas, one is also left with a residual mass of ligneous fiber and mineral salts suitable for agricultural use, and which can be composted. (See trio on [page 65](#)).

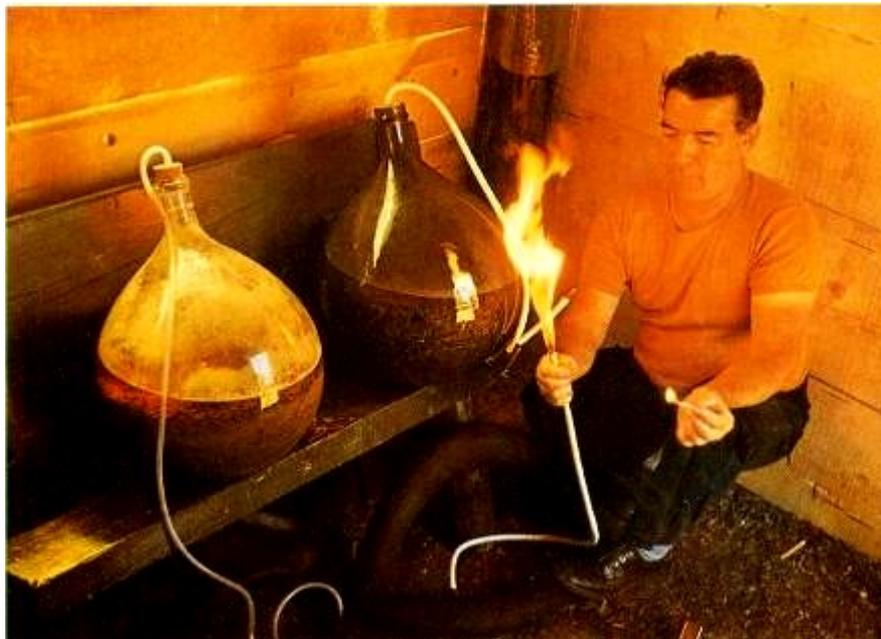

What better conclusion to this chapter ? .. Here is the flame illustrating the enormous energetic potential in what we call brushwood, that substance which is to be found all over our planet.

It is a symbolic flame, from which point anything can be imagined in matter of motive power; indeed, it is a **CONSTANTLY RENEWABLE SOURCE OF ENERGY**, and an inexhaustible one if Man is careful to maintain, safeguard and even increase these forests which are his heritage.

Here lies one of the few solutions to the problems of **ENERGY** which this society of ours needs; it will be the mark of the authentically Civilized modern Man.



17 / 09 / 78 First motor vehicle to be run on BRUSHWOOD GAS.

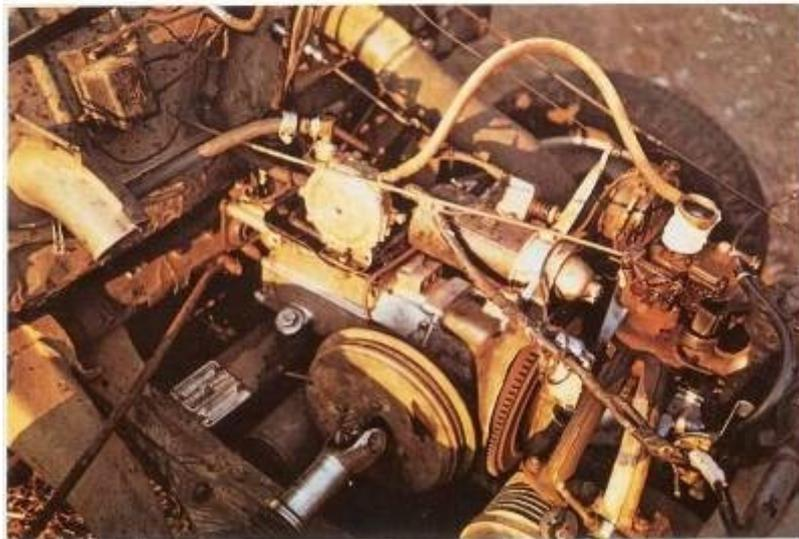

Close-up of modification in pipe leading to carburetor.

FOREST

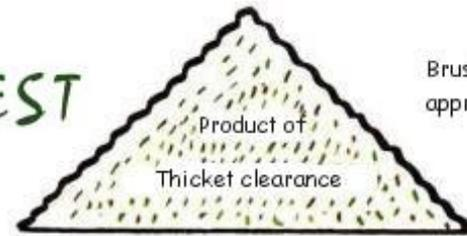

Brushwood :
approx. 10 kg

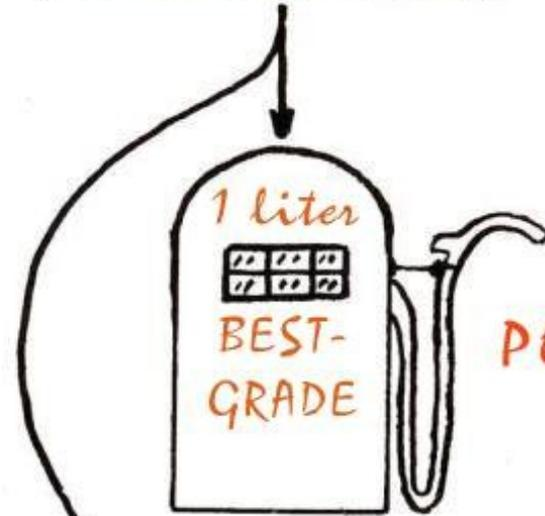

POWER

SOIL

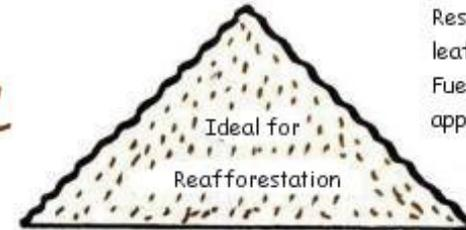

Residual
leaf-mould after
Fuel production
approx. 10 kg

Schematic Organigramme of "ANOTHER KIND OF GARDEN"

THE METHODS OF Jean PAIN

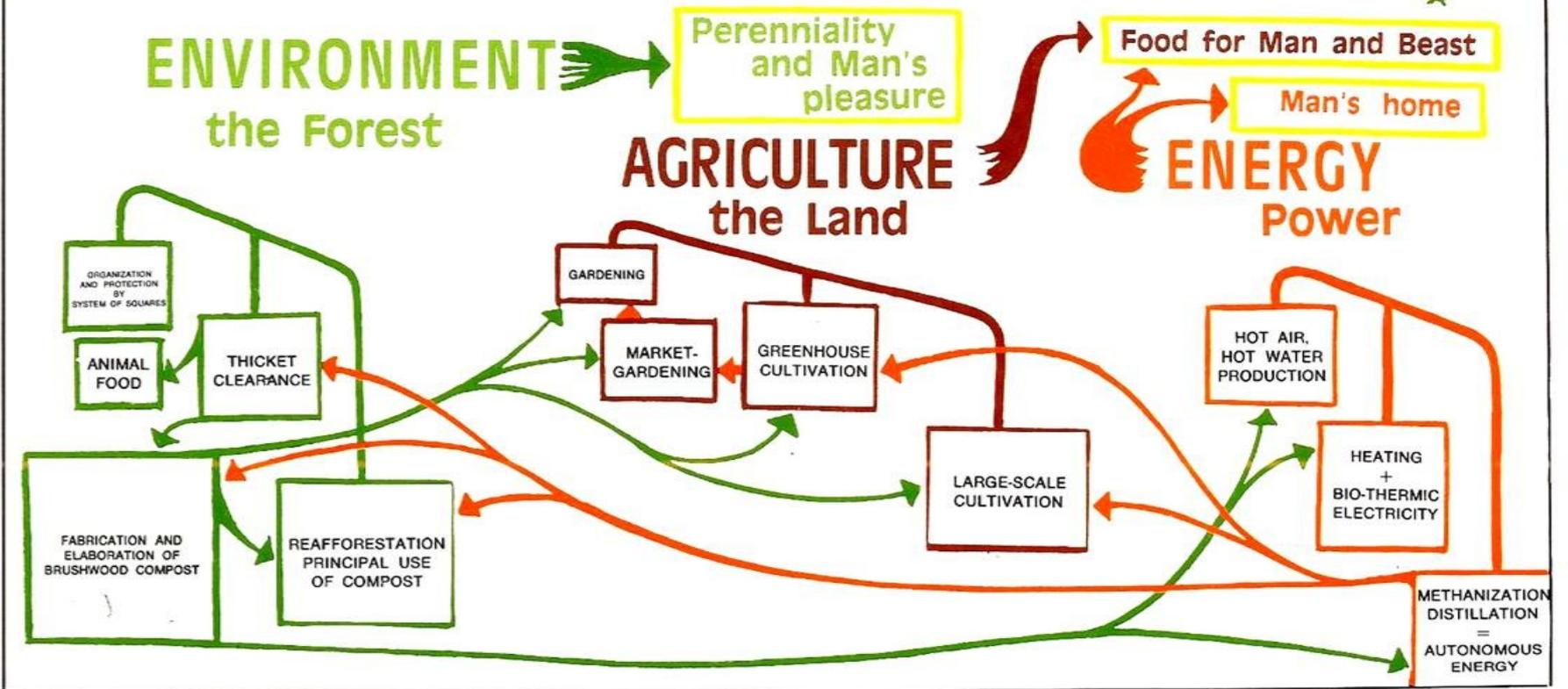

A FEW NECESSARY REMARKS

Each year, the Forest of the French Mediterranean Basin are badly damaged by Fire. (Our Methods are not yet applied everywhere, although we hope they soon will be). The forests are very popular places and the risks of fire very great : carelessness, thoughtlessness, accident, etc. Apart from this, wood-cutting is no longer profitable; the undergrowth reflects this and explains why thickets are so abundant, why there are fires, why they spread, and why , sooner or later, the forest will disappear altogether, with so much damage being done to the vegetal covering.

We should NEVER forget that the Jean PAIN Methods are concerned first and foremost with the renewal, the protection and the safeguarding of the forest, wherever it may be.

The Methods seek to maintain it, save it and replant it, by making agriculture and energy part of the forest cycle.

From time immemorial, Man has intervened in the forest, and not always for its good; but what we want to do is to look at it in a new light. The forest is going to become more and more necessary to the human race, not only for its material benefits, but also for its moral and spiritual well-being.

Saving and replanting the forest is all part of the program to which Man must devote his energies, in the same way that he cannot accept the image he has given himself of the sawyer sitting on the wrong side of his saw on that notorious branch; otherwise, what is the point of saying we have understood if we don't bother to do anything about it ?

In the same way, we cannot go on applying our Methods in the future unless they can provide a solution to the problem of the ENERGY which they use for their own accomplishment. In other words, it is out of the question to carry on using a form of ENERGY for fuel which is foreign to our Methods, that is, not obtained from brushwood or other ligneous products.

Here, Agriculture and exploitation of the forest will find their fulfillment, there will at last be a positive balance-sheet for the energy problem whereas at the moment, to produce one agro-alimentary calorie, it takes ten times its equivalent in energy.

That, then, is the essential part of our objective. It isn't always understood.

It had to be said !



Experimental Center of the Jean PAIN Committee International, Hof ter Winkelen, 2900 LONDERZEEL (Belgium) .

Right foreground, the shed equipped with all our forms of ENERGY, next to it the production heap, on the left orchard, in the background, behind the windmill, the garden. Area : 2.000 m².

(Postal address of the Jean PAIN Committee International : 18, avenue Princess Elizabeth, 1030 BRUSSELS. Belgium Tél. 2-241.08.20 or 52-30.01.66).

This research, then, which was begun in 1964 in the Central Var, and which was aimed primarily at enabling a family of extremely modest means first to get by and then live normally in the forest, has today led to the production of ENERGY in the form of electricity obtained by means of simple techniques, (this not being our purpose at the outset).

Our work is advancing so quickly that the pen has difficulty in keeping up with what is already in effect.

In December 1978, it was decided to build a small electricity production unit, starting from wild plant matter (brushwood) gathered after thicket clearance; the reason for this decision was so that we might determine and communicate the overall cost of such a system. Today we are in a position to do so, although at the time of writing the experiment is not finished.

We allocated ourselves a budget of 30.000 F, and we were determined, in the light of all the experiments which had already been done, to put this relatively small amount (considering the extent of the project) to good use, mindful of everyone's interests.

An area of 10.000 m² (1 hectare) of forest was chosen, a kilometer away from our house, where the thickets were fairly abundant (40 tons).

Six people who were interested in our project were to take part : Lucie, Ida, Georges, Etienne senior, Etienne junior and Jean ; and since this is intended to be a financial study of the project, we must now talk about money. Each of us received a daily allowance of 100 F, plus board and lodging, which was reckoned at 50 F per working day. We didn't work for more than 6 hours a day, and that included getting from one place to another. It took 10 days to complete the whole job. That gives us : 6 people at 150 F for 10 days : $6 \times 150 \times 10 = 9.000$ F.

Equipment used :

1° 1 4 x 4 Renault lorry « tout terrain » (suitable for rough ground).

2° 1 38 HP I.H. tractor, P.T.O. + Jean PAIN Chipper.

3° 1 Citroën 2 CV van.

4° 2 « Kioritz » chain-saws, cost of hiring material, including insurance : 200 F per day, that is $200 \times 10 = 2.000$ F.

The equipment was in use for the following periods of time :

1° Lorry: 6 hours in all, that is an average of half an hour a day (10 min. there, 10 min. back, 10 min. to get things into place) plus an extra hour; fuel consumption : 100 liters best-grade petrol at 2,50 F = 250 F.

2° Tractor + Jean PAIN Chipper : 50 hours, including 40 hours of chipping and refining at a given point in the forest; fuel consumption : 100 liters fuel-oil at 1,00 F = 250 F.

3° Citroën 2 CV van carrying passengers, small material and provisions : 10 hours = 20 liters best-grade petrol at 2,50 F = 50,00 F.

4° 2 chain-saws working 40 hours in all : 60 liters 2-stroke mixture = 150,00 F

In addition, we used a ladder, a wheel-barrow, a pair of steps, 2 pair of pliers, a screw-driver and a hammer, for which the total cost was 100,00 F.

We bought 2 pitch-forks and a spade, together costing : 180,00 F.

It is difficult to give more details about the organization which imposed itself during those ten days that we worked together, except to say that it fell into place, according to the capabilities of each person for doing one particular job rather than another (keeping the supply of brushwood going, feeding it into the chipper, refining, or maintenance of the machinery.)

It is important to point out that none of those taking part was a specialist nor a professional with forestry training (apart from George who wields the chain-saw with a certain dexterity), and one can quite locally imagine that skilled workers, who are used to the job, could considerably reduce the time it took us.

At the same time, we were testing the capacities of the Jean PAIN chipper. In 40 hours of chipping and refining, we obtained the 80 m³ necessary, so the sum is simple : $80 \div 40 = 2$; our chipper is thus capable of producing 2 m³/hour of very fine brushwood; by « very fine » we mean an ideally granular chipped matter, with a density of 520-550 kg/m³, which does not have to be re-chipped. (Note that the figures we gave on [page 48](#) have greatly progressed, the granular matter obtained with our chipper being much finer).

It is now time to list the material necessary for the production of gas, the thermometric control of it, its stockage and usage..

1° One plastic tub, 4m³ in volume in this case, cylindrical in shape and 2 meters high (it should have a lid to cover the one opening necessary for filling from the top). Price : 3.500 F.

2° 1 sounding thermometer, 1 meter long : 160 F.

3° 200 meters of polyethylene tubing, 28 x 32 : 800 F.

4° 36 inner tubes, total volume 5 m³ (old ones, so no cost), plus adhesive rubber rings, joints and special Ts for gas, valves and on/off taps : 600 F.

5° One three-burner gas-ring : 150 F.

6° One Citroën 2 CV engine, 1955 model, 425 cm³, 12 H.P. (an old one again, so no cost).

7° One 8 KWh generator : 4.000 F.

8° Two 6 V battery, each 95 A/h, the two together : 600 F.

9° 25 meters of electric wire and one 12 Volts, 100 Watts lamp : 90 F.

10° Complete equipment for running an engine on gas : 950 F.

HOW WE SET TO WORK

The system happened to be set on a rocky hillside facing north (our house is on the same hill); as soon as the first load of chipped brushwood was brought along, it had to be unloaded in such a way as to ensure that the finished heap would be level; as soon as we had got a thickness of 50 cm at the center of the heap, we put a tub there and immediately three-quarter filled it, so that we had 3m³ of brushwood compost which was more than 24 months old (it was the only compost available at that moment, and it was same compost which had heated the greenhouse two years previously !). We then added water until the brushwood was completely immersed.

The next day, even before unloading any more chipped matter, we wound 200 meters of polyethylene tubing round the tub, the linear unit being assured by the special joints; we fixed the top end of the tubing securely, so that it would not unwind, and then started unloading more of the chipped brushwood. We carried on unloading during the days that followed emptying it round the tub and heaping it up progressively, spraying water on it as we went.

Before the tub was completely covered by the brushwood, we welded the lid on to the plastic. Through the lid we had fixed the sounding thermometer, which was to show us the temperature inside the tub, and a 10 cm long cooper tube which would allow the future gas to escape.

All we had to do then was to finish the heap by covering the top part of the tub with 50 cm of chipped matter..

The reason for winding the polyethylene tubing (through which the water will circulate) round the gas-production vessel, is simple, and quite a clever idea : the circulation of water makes it easy to control the temperature inside the tub; we know that fermenting compost gives off a heat of about 60° Celsius ; we also know that ideally methanogenesis occurs at around 36° C. The reader will easily understand the rest; according to whether our thermometer shows more or less than the ideal 36° C, all that needs to be done is to circulate the water to cool the mass being produced, or else stop it and watch the temperature rise.

Obviously, we make use of these fluctuations. We fix both ends of the polyethylene tube to a radiator which is keeping one room of the house at a moderate temperature; the temperature of the radiator/cooler hardly ever rises above 30°C while the water is circulating; we must remember that there is a relatively large mass, 4m³, which produces little heat at the center of our heap. (the sketch on [page 74](#) illustrates this)

The whole system works quite simply; the brushwood compost, which is enclosed in the air-tight tub and gets heat from our outside heap of 80m³, produces a supply of gas over a period of five months averaging 1.300 liters, per day, depending on whether the temperature at the center is maintained above or below 36° C by means of our cooling system described just now.

The gas produced is then channeled into 36 inner tubes, where it will be stored. The tubes expand and contract with the rise and fall of the day-time and night-time temperatures.

From there, the reserve of gas is connected to a working system, which in this case consists of the two gas cookers in our home, the depressurizer-carburator supplying the engine, which in turn works its own dynamo, the 8 KWH generator and the compressor being used to fill the high-pressure cylinder which supplies the engine of our utility vehicle (Pictures [pages 75 and 84](#)).

At the time of writing, our generator is not yet connected to any electrical appliances, that is washing machine, refrigerator, etc., and our demonstrations are limited to lighting, cooking, the working of the electric generator and the running of the 2 CV van.

The 80m³ « heat-producing » heap will generate heat for 18 months, and so we plan to use these calories to refill the tank twice before putting the heap itself over to methanization in a future, much bigger, system, which will be capable of producing 100 KWH of electricity.

Coming back to the present system, let us make a provisional and provisional estimate.

First of all, the total cost of the project : 9.000 F plus 200 F plus 250 F plus 250 F plus 50 F plus 100 F plus 180 F plus 3.500 F plus 160 F plus 250 F plus 800 F plus 600 F plus 150 F plus 4.000 F plus 600 F plus 90 F plus 950 F = 23.080 F.

To this must be added a further 1.400 F justified by the time it takes to regulate, adjust and put various finishing touches during the whole of the first month it was in operation. That makes a total outlay of 24.480 F, (which I shall call a round 25.000 F to make the calculations that follows clearer), to make what could be called a trial run for producing electricity from brushwood compost, using the methods which are dear to us.

After more than two months spent in making notes and recording facts we can consider our estimations to have been amply corroborated by the actual production of gas; indeed, in the first 70 days, there is already a production of 106m³, and sometimes we even burn the excess.

For the moment, however, we will not give a financial report of our project. That will be done during the course of the present year. On the other hand, it is easy to learn a few thing from what is being done.

Firstly, and this is most important, 1 hectare of woodland has been rescued from the danger of disappearing by fire, all to the good of the remaining plants; (to give you an idea, this operation alone usually costs 8.000 F per hectare, whereas here it costs nothing – in fact it gives us something in return). Secondly, the product of the thicket clearance will, we know, provide 50 tons of agricultural fertilizer of inestimable, but calculable, vital humic value : take a certain quantity of brushwood of equal nutritive value, bought loose at the average cost price of 300 F per ton. That makes 300 x 50 = 15.000 F. That would already cover a good part of our expenses (if we decided to commercialize the finished product, which is not the case). Then, if we make a list of the material lefts after it has been used once, we have a total of 11.380 F, is comes as a surprise to discover not only that it has paid for itself, since from the very first small-scale operation the expenses are covered,

but also that it has made a profit of 1.380 F, that six people have earned their living (amply) for 10 days, and no distinguished economist could deny it. (The reader will have noticed that only the material which cost us anything has been counted in our totals).

We also know that these 50 tons of agricultural fertilizer, in the form of brushwood compost (and representing 40 tons of chipped brushwood) are also capable of producing the approximate equivalent of... 4 000 liters of best-grade petrol by methanization before being used in agriculture, or, better still, in silviculture, in conjunction with the reforestation program.

One of our next objectives is to demonstrate the use of our gas in the work of thicket clearance, chipping, refining and carrying of the raw material, in order to obtain an energy balance which will bring even more positive results :

BRUSHWOOD which can treat itself by means of its own **ENERGY** !

At the same time, we are studying the best way of liquefying our gas, so as to enjoy a much greater autonomy, since the volume will be much smaller – a thousand times smaller, in fact. This will be particularly interesting for vehicles which are driven hard and for long periods, and for ones which are likely to do long journey.

Here we are again, then, with a lot on our plate.

RUDIMENTARY DIAGRAM OF SYSTEM

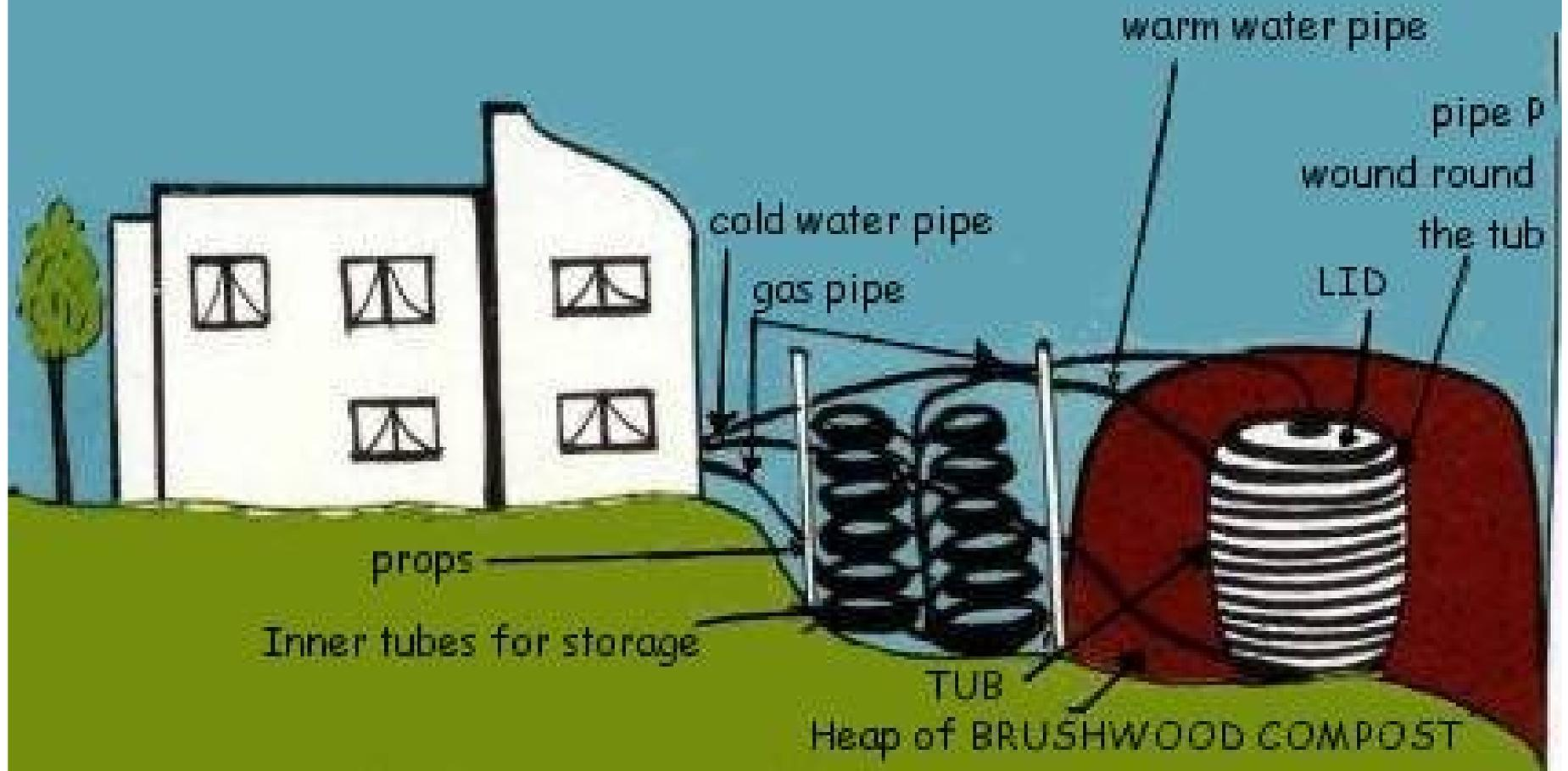

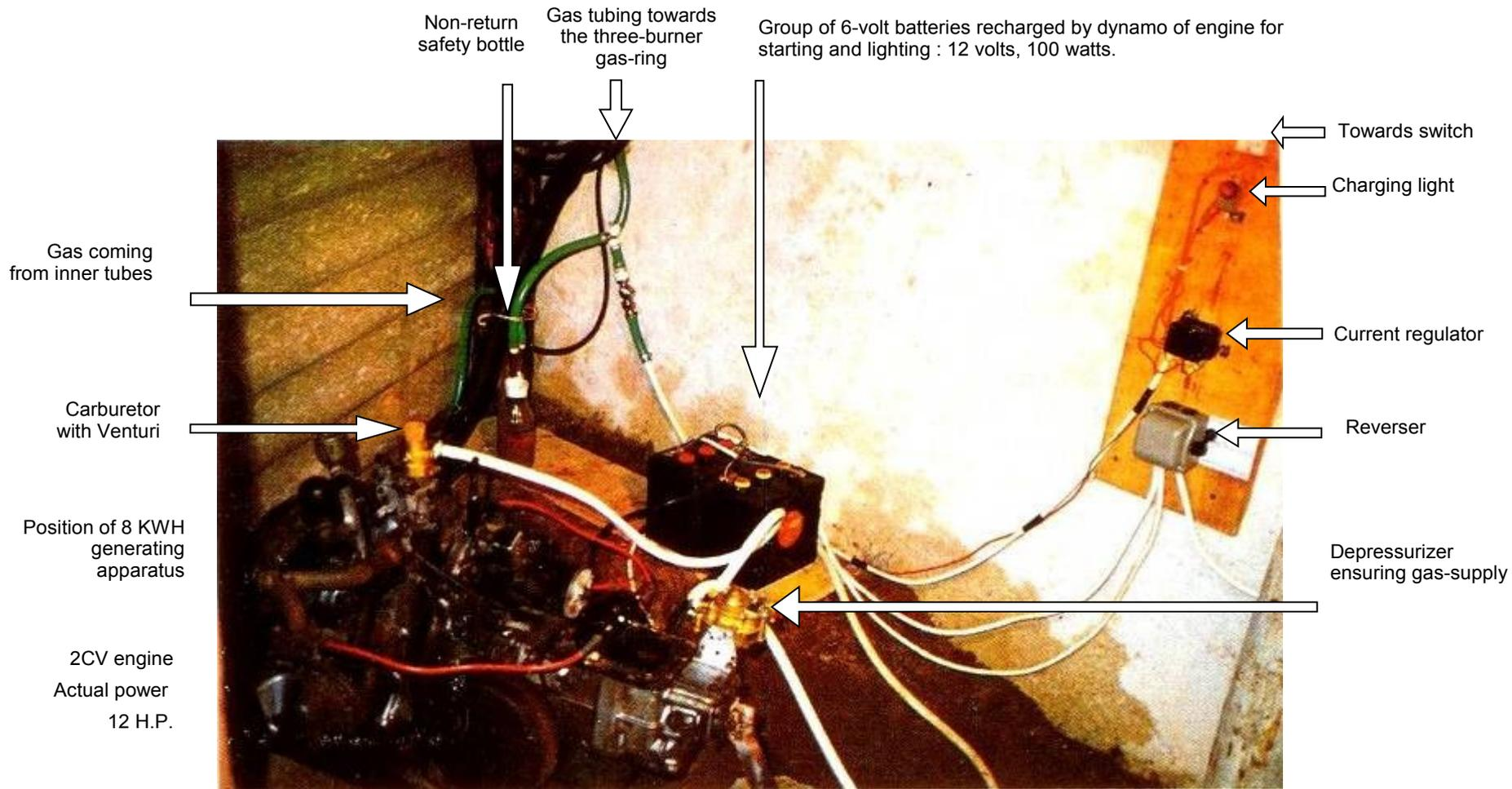

JANUARY 1979. – FIRST BRUSHWOOD GAS ELECTICITY PLANT.
POTENTIAL POWER 8 KWH.

THE JEAN PAIN PLAN FOR BRUSHWOOD CLEARANCE AND RATIONAL USAGE OF THE RESIDUAL FOREST BIO-MASS

Throughout the preceding pages, we have seen how we can best use Brushwood Compost in gardening and agriculture.

At the request of several agricultural and forestry organizations both in France and abroad, I have produced a plan for the best usage of what I shall call the Residual Forest Biomass, (that is the biomass from branches, the top of trees, leaves and needles which are just left on the ground or else burnt at great expense, as is the brushwood in the Mediterranean forest), particularly in conjunction with the efforts to combat the spreading of fire.

This plan, then, is the consequence and extrapolation of what I have learnt and experienced in the forest during the last seventeen years.

According to all the correspondence I receive daily, the text is too short, the technical details insufficient and the amount of information about the financial side far too limited. I hope that what follows will remedy this.

The basis for this plan is an imaginary area of forest of 1 000 hectares, which we will situate geographically in the Central Var for its topographical difficulties of accessibility. As we said at the beginning of this book, the thickets should be cleared using a system of squares, rather like a draught-board, but taking the relief into account, since it is not worth clearing areas which are particularly difficult to get at (rocky heights waterfalls, steep, or even perpendiculars, slopes, the sides of rocky paths, etc...)

SKETCH OF THE PLAN

Main access road
about 1 500 m

Existing or newly
made-up forest
access paths

Cart-tracks made
up to prolong
access

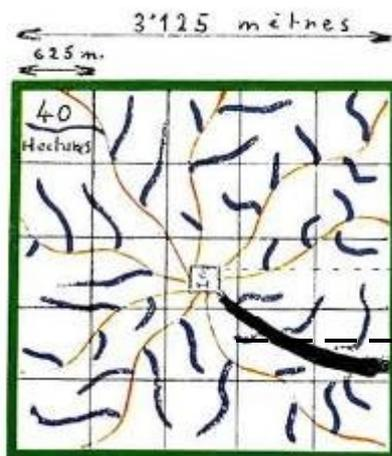

Each square represents
40 hectares and contains
1 600 tons of Brushwood
to be gathered every 8
years for a period of at
least 24 years.

Infrastructure, homes,
composting area : 8
hectares (the first to
be cleared)

It is not a question of turning the forest into an orchard, but of selecting plots averaging 40 hectares (about 625 meters each side), and to which access is possible, thought not necessarily easy. Each of these well-defined plots has a potential 1 600 tons of brushwood which must be cleared for the forest's --

-- benefit, both to prevent fire from progressing and spreading, and also to allow the remaining tall specimens to grow and develop in the vital extra space they will then have. (SIX years after the first thicket clearance, the result was spectacular and the forest, unrecognizable).

One should gather plants belonging to various families and species, according to the environment, but in all cases plenty of the leafy, rather than the resinous, varieties.

We must explain here, briefly, the reason for this deliberate choice.

From long experience, we know that the resinous species grow, and therefore spread, more quickly than the leafy varieties; we also know that the presence of the former just causes the soil to deteriorate, whereas the latter improve it constantly.

Not only that, but the atmosphere of resinous forests in no way favours the ecosystem, whereas there is no need to list the qualities of leafy forests with their tall oaks, beeches, etc...

This, then, is just a brief summing-up.

Up to now, the only clearance carried out by the public services has been that of roadsides, forest-tracks and fire prevention « screens » (the effectiveness of the latter is a debatable point, incidentally, apart from the fact that the « screens » could enable fire-brigades to intervene more quickly).

My mind goes back to what I saw in that terrible October of 1970 in the Massif du Tanneron – minute firebrands being carried more than three hundred meters by the violent Mistral and then setting fire to the neighbouring forest.

In March 1978, I had confirmation of that evidence on the forest-land where I live; we found more than a hundred spots where such firebrands had started fires, on the very land where an area of forest had been cleared, incidentally. In those spots the fire just burnt itself out, since there was no « fuel » for it, and this without any help from the fire-brigade, while all around the fire raged and in the space of a few hours destroyed six hundred hectares of forest.

This just goes to show how important it is to clear the forest itself, and not just edges.

The average charge for a typical thicket clearance can be put at about 8 000 F per hectare (1st October, 1979) and there then follows the no less typical incineration when weather conditions permit.

Now, for the first time, using the Jean PAIN Methods, we can, thanks to the profitability of these applications, conceivably do away with this expense and seriously envisage saving the forests of the French Mediterranean Basin from the fires which threaten their destruction, without having recourse to a ruinous subvention.

Let me come back to our plan and explain what I mean :

1st point : At the center of this area of 1 000 hectares, we will set up the infrastructures necessary for the project, that is : a well, temporary prefabricated living-quarters, rather like forest hamlet, a fairly powerful electric generator, 50 kW/h, which will be run on "imported" gas, until we get our own supply in six months' time, and which will ensure the energetic autonomy of the site and of the project, and a stager compressor with a power of 300 bars.

2nd point : This model Unit of 1 000 hectares will provide jobs for 16 active people for at least 24 years, and maybe even longer, depending on how the forest-industry develops in the future.

N.B. : These 16 people are divided into 3 team of 4 : as for the remaining 4, one will do the composting, keep check on the fermentations, be in charge of the site and of methanization, one will be the mechanic for general maintenance of the machinery, chippers, compressors, etc... one will do the office-work and book-keeping, and one will be the Unit Foreman.

Each team of 4 will have a working area of approximately 320 hectares. The team will be responsible for TREATING the area over a period of eight years, at a rate of 40 hectares per year, which exactly corresponds to one square of the suggested " draught board ".

3rd point : TREATING : that means cutting any undergrowth right down, doing away with low branches and cutting back Shrubbery, leaving about 1 200 specimens per hectare, gathering it all up, chipping and refining it, sending it to the composting area at the center of the Unit, unloading it and then spraying it to keep it moist.

4th point : The technique for the progression of the clearance will be as follows : once the annual 40 hectares have been cleared, the team will then move on 625 meters to start the following year's work. The reason for this ? Precisely to enable wild creatures to nest and build their homes in order to maintain a certain balance in the natural environment. In fact, the second square will not be cleared until 4 years later. In this way, the initial plan for thicket-clearance is respected for the benefit of these forests whose balance is so fragile.

I hope I have made myself clear as to how the work should be carried out.

5th point : Let us now speak about the material necessary for this type of job : it should be light, easy to handle and uncomplicated; medium-sized and small chain-saws, standard brushwood-cutters, Jean PAIN's chipper-refiner, (the only one adapted to the Methods), either fixed on to an 80 H.P. farm or forest tractor or to a special "caterpillar" tractor of the same horsepower. The vehicle carrying the chipper product should be a 40 H.P., 4-wheel drive 2-axel one with a 4 m³ tiltable bucket (let us remember that all this machinery will be run on gas from our own supply six months after the Unit becomes operational).

6th point : It is important to emphasize here that in spite of the relatively large expanse of the Unit (1 000 hectares), the furthest transport vehicle from the center, that is from the composting area, should be no more than 30 kilometers away, even if there are winding paths, and this from only the eight year onwards. I attach great importance to this aspect of the organization.

One can easily see why : it is necessary for the well-being of the people on the job and for keeping the material in perfect working order, since it, too, has to move about. Workers and equipment help one another.

With this type of organization, the cost of the finished product can cost three or even four times less than it would if the work were done by a firm which had to fetch brushwood from a long way and bring it back to the site for treating.

In our endeavours to obtain the lowest possible production cost, economizing wherever we can and wasting nothing, this aspect is, I repeat, primordial ! Not to take it into account would be to remove much of the credibility of these Methods as a whole and make the people of the region who are watching it go to pieces hostile to the Methods.

7th point : Techniques of combined industrial production of brushwood compost and brushwood gas; I can say, without pretension, that I have most probably heard about all the techniques of producing methane gas from the most diverse basic elements, but which I shall not list here.

I think I can say, though, that I have never heard of methanization from a substance such as the one that interests us, that is from brushwood, in other words wild plant-matter, which is irreplaceable and which acts on its own without any accelerator or other bacterial yeast. At no stage of its elaboration does its aspect or smell become repugnant; it even has a pleasant smell and its emanations range from the aromatic scent on the day of chipping-refining to the more profound scent of the humic substance when it is applied in agriculture. Not to mention the intermediary stage the day it is removed from the methane tub, when it is the smell of crushed carbon which dominates, giving a rather heady smell.

The brushwood, once ideally refined in the forest, is transported, unloaded, then heaped up and moistened in the central area up to a volume of 80 m³, which roughly corresponds to 1 hectare and a week's work for one team.

At the center of this heap, a space will be cleared, in which the 25 m³ tub will be placed.

We then have a heap of 105 m³, all in, and one should proceed with the production and storage of gas as described on [page 72](#), except that here one will obtain 2 000 m³ of gas per tub over a period of 4 months. The gas supply should be directed towards one the two 1 000 m³ storage tanks; a tank from which we will fill special cylinders at high pressure (200 bars), and which will either be used in the Unit itself, or else be commercialized like any other gas well-known and widely distributed in France, such as Lacq. It will be used in the usual way for hot-plates, cookers, arc-welders, internal combustion engines, heaters, etc...

Last year I found that it was no longer necessary even to maintain an "ideal" temperature of 36°C during the course of production, that it was possible, and even preferable, to let the temperature rise freely. The higher the temperature is, the quicker the methanogenesis of the brushwood compost, within the limit of that obtained by the brushwood, (4 months instead of 6), the quantity and quality being the same. The quantitative figures I gave at the beginning of the operational phase were confirmed beyond any doubt, and I may say again that 10 kg of brushwood which have been ideally refined in our chipper produce 2 m³ of gas,

which represents 11 000 kilo-calories, that is approximately 1 liter of Petrol Equivalent : the 10 kg of brushwood of brushwood have become 8kg 500g for an identical retention of water.

We can already say here that the Unit would produce on average 6 000 tons of agricultural fertilizer (average cost-price on 1st October 1979 : 600F per ton, making 3 600 000 F) in form of brushwood compost of high humic value, plus 960 000 m³ of usable gas, representing 480 000 liters of fuel at 11 000 kilocalories per liter. Sold in cylinders at cost price and in bulk, that would be 1 F, making 480 000 F- (We have not mentioned the millions of liters of hot water at 60°C which could be produced during the elaboration of the gas and the compost, this type of CALORIFIC ENERGY being difficult to condition and export; but this technique can well be used in the Unit itself, for heat the living-quarters, for example, or for the hot water supply).

8th point : This, then, is my new way of applying the Methods.

1. – Finer granulation from the start, which we owe to our chipper.
2. – Different pre-composting : 2 months.
3. – Shorter methanization period : 4 months, because it, too, is different.
4. - Finally aerated “quickly” composting: 1 months

The new generation of Industrial Brushwood Compost can now be used in agriculture from the 8th month, whereas, with the old formula, as the book shows, it often used to takes 18 months.

The economic world is very sensitive to this type of argument. There would even seem to an improvement in the quality in agricultural application, but I think it is too soon to say more.

9th point : We can now go on the question of investing in equipment : each team of 4 has a 40 H.P., 4-wheel drive, truck with a 4 m³ tiltable bucket : price : 90 000 F – 1 80 H.P. forest tractor : 70 000 F – 1 Jean PAIN chipper : 50 000 F – 1 medium-sized chain-saw : 2 000 F – 1 small chain-saw : 1 400 F – 1 thicket-clearer : 2 400 F – plus small material for maintenance : 1 000 F – working clothes and safety accessories, renewable three times a year : 4 000 for each team, making 228 800 F . 3 teams to each Unit : 228 800 x 3 = 686 400 F .

So much for the forest side..

Let us now take a look at the composting area : drilling well and filling pump, out-put 5 000 liters per hour with 50 kW/h generator : 90 000 F – one 60 H.P. loader : 70 000 F – one Jean PAIN heap ventilator : 60 000 F –pierced hoses + miscellaneous (pitch-forks, spades, etc...) : 5 000 F – Total : 225 000 F.

Now for the gas production and conditioning department :

160 25 m³ plastic tubs, specially designed for the methanization of brushwood : 1 250 F each = 200 000 F – connecting accessories : 20 000 F –

2 1 000 m³ “Beaudruche” storage tanks : 40 000 F x 2 = 80 000 F, + fixtures and protection : 10 000 F x 2 = 20 000 F – 1 stager compressor : 50 000 F – 1 pump Jean PAIN for loading and emptying the tubs : 18 000 F – CYLINDERS : in every case the cylinders were returnable and we had to get legal permission to fill them, since they were to be used as car fuel-tanks, so we shall not give the figure. Total : 388 000 F

NOTE : I must inform the reader that all this equipment is at present being studied for global distribution at as cheap a rate possible by an Engineering Firm with which I am in permanent contact. This firm is working on the possibility of fitting the equipment, and even that of delivering ready-to-work “kits”. I am, of course, at the disposition of anyone who would like further information.

It can be seen, then that it takes an investment of 1 899 400 F worth of equipment (excluding taxes) to make the Unit operational.

To this figure must be added the salaries and miscellaneous expenses of 15 people; I would therefore put the average figure at 8 000 F per person per month, including expenses : 8 000 F x 15 = 120 000 F – multiplied by 12, that makes 1 440 000 F per annum, the Foreman earning 200 000 F per annum, including expenses.

One must allow a float for the initial exercise which I shall put at 150 000 F, corresponding to the outlay for fuel and oil mainly, plus 300 000 F for making up or improving paths.

It thus takes a total of 3 989 400 F to put this Unit of 1 000 hectares into operation.

The equipment pays for itself in 5 years, and this includes changing parts, and the loan, including interests, is paid off in 10 years.

ENERGY RECORD : 12% of the ENERGY produced by the Unit is used to run the Unit itself; counting everything in : ore, siderurgy, tires, wood, textiles, etc... : 26%.

Obviously, I should like to see an enterprise like this one become part of the Public Services, or at least work in conjunction with the Public Services. For it is, once again, a question of safeguarding, protecting, maintaining and improving the Mediterranean environment which is threatened by that great Destroyer, the forest fire.

Once again, our Methods are first and foremost designed to serve the Forest wherever it may be, and all other interests are, to our mind, secondary.

Just think that it is a question here of trying to safeguard 1 000 hectares, with success guaranteed, that 16 people will directly find a well paid job, that the equivalent of 480 000 liters of motor fuel will be produced each year, as will 6 000 tons of this precious humic improver which has great value as a fertilizer, and which could even enable reafforestation of the same number of hectares in the same year.

Just think that from the end of the very exercise, a good part of the investment is paid back from the sale of Brushwood Compost at a very competitive price : 3 600 000 F – i.e. more than 90%, and that part of the 480 000 – in the form of gas, could find an outlet, although that is a more hypothetical point at the moment, with the product being little-known and the market at present non-existent.

Finally, remember that the upkeep, indeed the very existence, of the Mediterranean Forest is at stake. The words of an eminent specialist in forestry come to mind : « If the Mediterranean Forest did not exist, it would have to be created ». This was said to me ten years ago by George PLAISANCE, who was at that time Director and Chief Engineer of the Regional Forestry Commission at Marseille. I shan't remind you of the deadly fires of August 1979 and the dramas they caused, except to encourage anyone who has any influence or power to give careful thought to what this Plan proposes.

In conclusion, it must also be remembered that such an industry implanted in the South of France would provide thousands of well paid jobs, and at the same time It would PRODUCE ENERGY, and there is nothing to prevent one from imagining, for reasons quite different from those considered above, the Southern forests as a profitable concern, using the same Methods.

Villecroze, 15th October 1979.

P.S. – Minimum possibility for annual production of the Var Forest (for its own benefits), using the JEAN PAIN METHODS :

- Exploitable area : 400 000 hectares

- Production of young HUMUS in the form of Brushwood Compost : 2 400 000 tons.

- Production of FUEL in the form of Brushwood Gas : 192 000 000 liters, that is 192 000 tons of Petrol Equivalent

- 6 400 new jobs, plus a number of others created as a result of the former.

- Economy of 1 440 000 000 F in importation of humerific products and of 192 000 000 F in Petrol.

Here are a few figures to bear in mind concerning forests, since they, too, may be used for the application of the Plan : the French Forest covers an area of 14 500 000 hectares, the Belgian Forest 960 000 hectares, and the Californian Forest 17 000 000 hectares (about 42 000 000 acres).



Loading the Brushwood Gas production tank by hand. (loading and emptying now done by automatic pump of our design.)



Delicate operation : compression of the Gas into storage cylinder



Clearing, chipping and refining... the team in action.

That, then, is the plan, which may have its derivatives. The town of Seattle in the State of Washington, U.S.A., and, on a smaller scale, Saint-Raphael in the Department of Var, France, have appealed to us to solve their problems of recycling organic or ligneous matter. In Belgium (1), where the Center is, similar request have been received from many communes round about. In each of these case, it is possible to adapt, in the same way that it is possible to adapt to the scale of an agricultural farm, or a forestry business, or the amateur gardener working on a bigger areas than those we were speaking about at the beginning of the book.

Take the example of Saint-Raphael : for reasons of upkeep, safety and environment, the commune, which owns vast expanses of woodland, has for a number of years had this clearing work done by a private firm whose job it is to take the brushwood to a factory 20 km away, where it is burnt. Up to now, these various operations of clearing, carting and burning have engendered considerable expense and have brought nothing in return; there are 4 500 tons of brushwood a year ! That represents roughly the tonnage that a Unit would produce, also over a period of one year. In this particular case, we advise the local council to adapt our Plan to the situation, that is to set up a site on a piece of council land (at least 4 hectares) for treating brushwood and ligneous products obtained from the branch-cutting.

This site should be equipped with the material which figures in the Plan, except that it will not be necessary to build certain of the infrastructures which come under the technical services of the town. These figures must be multiplied by 100 if they are transposed to the town of Seattle, U.S.A., where we shall be going shortly at the request of the municipality to advise them on the spot.

Another derivative of the Plan, on a much smaller scale : for a farm which has only twenty of so hectares of forest, thickets, or other « garrigues » the investment will be limited to the Jean PAIN chipper (which is an absolute necessity in every case) and the equipment relative to the production and conditioning of Gas.

Indeed, every farm has its own tractor, and its material for transport, and often a mechanical fork-loader fixed on to the tractor which is used for transporting and loading stable-litter. In this other special case, where there is only a limited supply of raw material (about 100 tons of fresh plant matter a year), the farmer will soon get his money back by using Gas as a source of Energy on the farm itself, and for hot water in all the applications already described.

The forest industry being close to that of the farm, in other words one of its revenues, the forester will organize his work according to the possibilities open to him; for example, the product from the periodic felling of adult trees is treated on the spot, on condition that there is water to hand; river, lake, pond, spring, etc... or else this same by-product is chipped on the spot and then immediately taken to the farm to be treated in the way we have previously described at length.

Finally, a great number of people have heard about our Methods and have decided to employ them on their own scale; not a month passes, but we receive dozens of letters from amateur gardeners asking advice about buying a

chipper capable of reducing to an ideal texture twigs, small branches and various kinds of brushwood gathered here and there for the family compost heap. We have been working for years now to find a solution to satisfy these hundreds of requests. We have not yet built the equipment required for this type of chipping, and the task is proving very difficult. (incidentally, no chipper on the market has received our approval). One would think that a small measuring 2-3 cm in diameter would be easy to break, but in fact it takes a very strong machine which can stand up to repeated vibrations and shocks; we are, however, on the point of producing a completely new system of hacking which will fill the gap, one which will be somewhere between the manual application of our Methods of gardening, needing only a fork and a scythe, and a farm-scale application, which implies the use of the Jean PAIN chipper, the only one available at present.

It is clear that in every case adaptation is possible and the list of solutions inexhaustible. Common sense and cooperation between individuals will count for a lot, and that is what we mean when we talk about the Man who is preoccupied with the Energy problems of his time.

(1) at [LONDERZEEL](#) : the Innovator of the Center, Frederik VANDEN BRANDE, has managed to convince the townspeople and people from round about, with the result that every day one can see them carting fresh plant matter from pruning, branch-cutting, and other clearance of spinney, thickets and copses. These various parts of the vegetal Biomass are carried on car roof-racks, in the boots of cars, on the carriers of bicycles and even in wheelbarrows by the children. The Service of Open Spaces of the town also bring along hundreds of kilograms of branches daily, all this is immediately chipped by those in charge of the Center and then made into Brushwood Compost for the uses we know.

The Center has been operational since 1974, and has played a large part in making our ideas known in Belgium, Holland and Luxemburg, where we have many adepts.

IDA and JEAN PAIN

Authors - Editors

83930 VILLECROZE

FRANCE

All rights of reproduction, translation and adaptation
reserved for all countries.

Ministry of Interior N° 023230 – National Library N° 10424

7th edition : (1st term) 1980

First edition printed in 1972 by

Ancienne Imprimerie NEGRO – 83300 DRAGUIGNAN – Tél. (94) 68 00 90

THE METHODS OF JEAN PAIN

OR

"ANOTHER KIND OF GARDEN"



ENVIRONNEMENT



AGRICULTURE

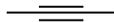

ENERGY



To the Reader :

This is the only reference book on the work of Jean PAIN and the applications of his methods; any other writings, sketches, diagrams, drawings, audio-visual recordings or other such publications claiming, even in part, to be a faithful report of his work, (except for the mention : « published with the consent of Ida and Jean PAIN »), can only be regarded as fraudulent and inaccurate.

The Authors.

To end this
slideshow, please
click here

To go to each part of the book,
click on the corresponding name

To return to the start
of the book, click here